

PRIMO LED Flood Light

5 YEAR
WARRANTY



Areas of application

- Recreational sports
- Billboard lighting
- Accent lighting
- Parking lots
- Roundabout
- Outdoor sports

Product Benefits

- Up to 100,000hrs @ L70, low maintenance cost
- World class, approbated quality components (LEDs /Driver /etc.)
- Tempered glass cover, easy for cleaning
- Compact die-cast structure, solid mechanism and reliable quality
- Atex certification allows the lamps to be used safely in flammable and explosive areas
- Optional installations accessories for recessed, surface and bracket mounting
- 5 years warranty

Product Features

- Luminaire efficacy: Up to 165 lm /w
- Lifetime more than 100, 000 hours
- Impact resistance: IK10
- Type of protection: IP66



Product Datasheet

Electrical Data:

Model No	ZGSM-GS04-80BF	ZGSM-GS04-100BF	ZGSM-GS04-120BF	ZGSM-GS04-150BF
Nominal Wattage	80W	100W	120W	150W
Efficiency(±5%)	165 lm /w	160 lm /w	160 lm /w	155 lm /w
Lumen(±5%)	13200 lm	16000 lm	19200 lm	23250 lm
Nominal Voltage	AC 100-240V /277V 50 /60Hz			
LED	Philips Lumileds			
Driver	Inventronics (Default) /Other brands on request			
Power Factor (PF)	>0.95			
THD	<15			
SPD	10KV (Build-in Driver) /Extra 10KV SPD (Available on request)			
Optics	25°, 60°, 90°, 120° or Asymmetrical			
Standard Deviation of Color Matching	<5 SDCM			
CRI	Ra>70 (Default) /Ra>80			
CCT	3000K, 4000K, 5000K, 5700K			

*Above values are calculated based on the product with CCT over 3000K, values of 3000K are 5% lower than above values.
 *Luminous Efficacy of Asymmetrical is 5% lower than other Light Distributions.
 *Values shown are subject to ±5% tolerance.

General Data

Body Material	High pressure die-cast aluminum
Housing Color	White
Cover Material	Tempered glass
Lens Material	UV-resistant Polycarbonate
Working Environment	-40°C ~ +50°C, 10% ~90%RH
Lifespan L70 at 25 °C	>100,000 h
Mounting Type	Bracket mounting
Mounting Location	Wall / Pole / Floor / Ceiling
Dimmable	1-10V Dimming (Default) /Timer Dimming
Protection Class	Class I (Default) /Class II
Standards	CE, RoHS, CB, LM79, LM80, TM-21, ATEX, IP66, IK10
Available on request	Motion sensor, NTC, OLC, DALI Dimming

Product Dimensions:

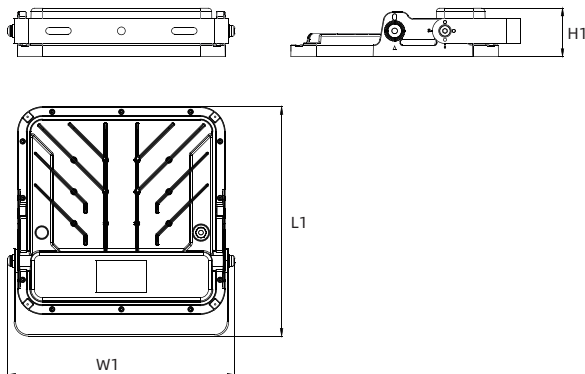

Fixture Information

Version	L1 xW1 xH1	Weight
Bracket Mounting	365 x361 x77mm	4.0kg

Packing Informations:

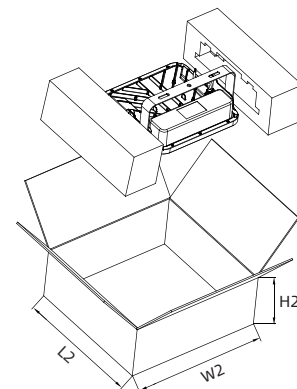

Package Information

Version	L2 xW2 xH2	Weight
Bracket Mounting	380 x380 x150mm	4.6kg

Product Datasheet

Light Distributions

Order reference

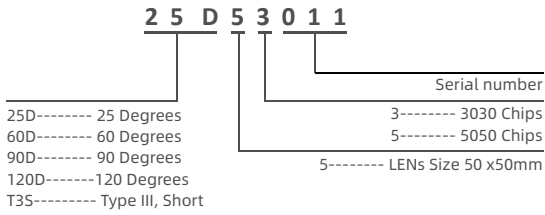

3030 Version

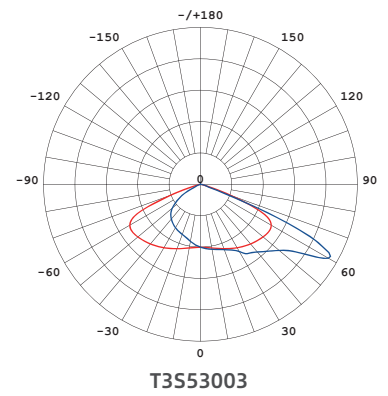
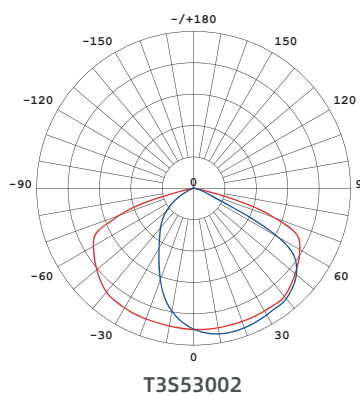
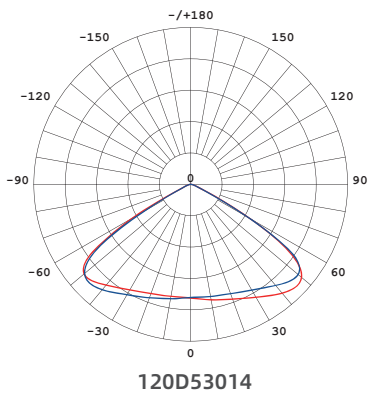
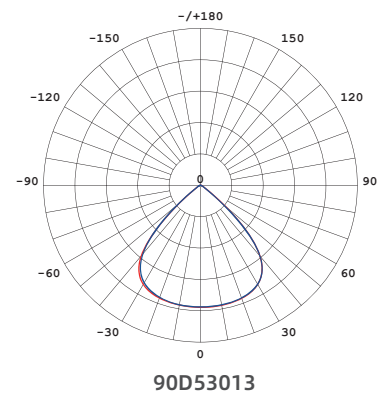
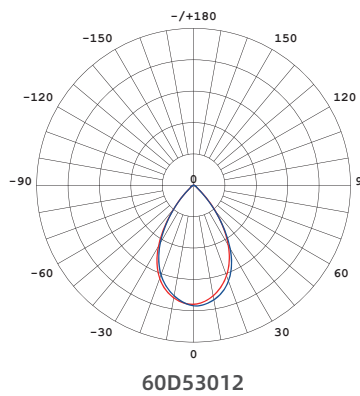
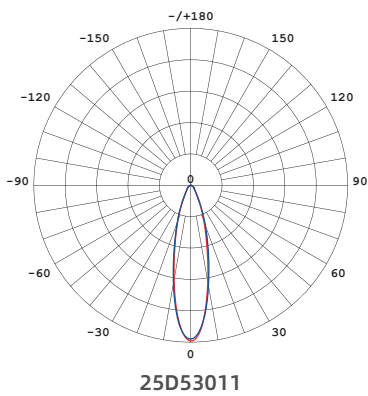

Optional accessories

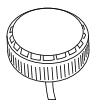

Motion Sensor

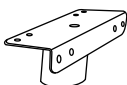

Pole Adapter

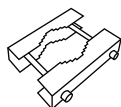

Clamp Bracket

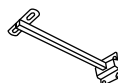

Mounting Arm



Extra 10KV SPD

Product Datasheet

Installation

Surface Mounting (Canopy Light)

Recessed Mounting (Canopy Light)

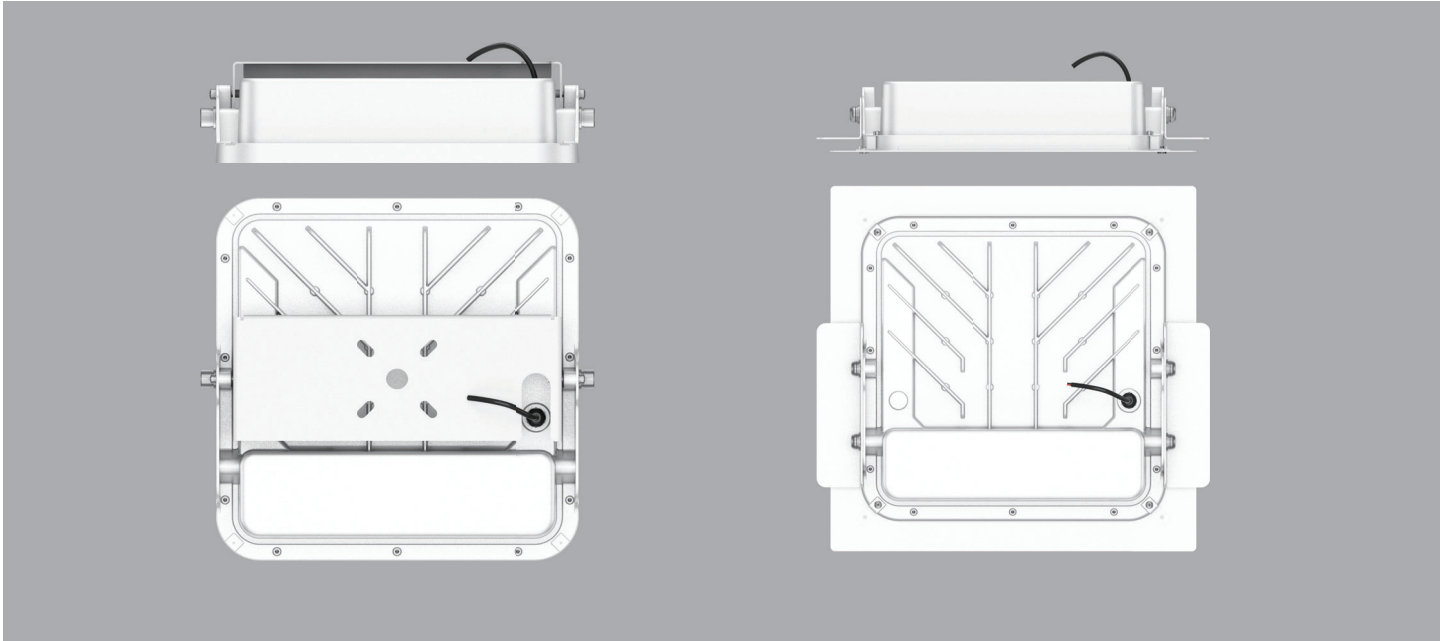

Bracket Mounting (High Bay Light)

Bracket Mounting (Flood Light)

