

# TECHNICAL

TÉCNICO    TECHNIQUE

CATALOGUE  
CATÁLOGO    CATALOGUE

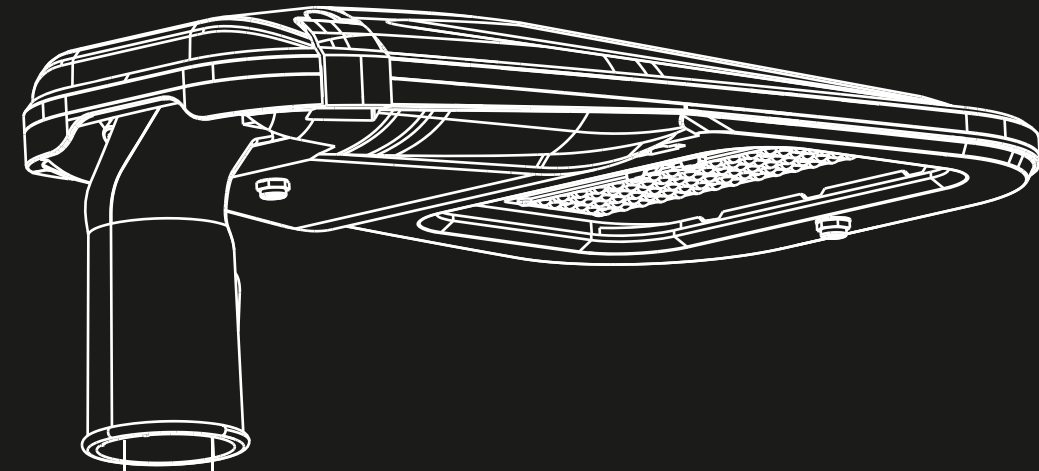

2022 Version 1.0

 **ZGSM**  
SAVE TODAY'S ENERGY FOR TOMORROW



杭州中港数码技术有限公司  
HANGZHOU ZGSM TECHNOLOGY CO., LTD

1188 Jinxi Rd.(S.), Lin'an, Hangzhou City, Zhejiang 311301, China

Tel: +86 571 63965892

Fax: +86 571 63968807

Email: [info@zgsm-china.com](mailto:info@zgsm-china.com)

[www.zgsm-china.com](http://www.zgsm-china.com)



# ZGSM Light Factory Expert in lighting

## EN

For over 17 years, ZGSM has been dedicated to creating a better quality, eco-friendly, efficient lighting environment through diverse businesses of LED lighting, traffic, solar and smart control system.

ZGSM has been rapidly developing its business all over the world since establishment. It was entitled as patent model enterprise and awarded as National High-tech Enterprise in 2009 and became a member of Illuminating Engineering Society and Semiconductor Industry Association in China in 2012.

ZGSM's R&D team is composed of over twenty members, each graduated from well-known universities in China and overseas in the areas of optics, thermodynamics, industrial design, electrical engineering, information engineering, arts, etc. The core designers are all well-experienced in domestic and international important programs for industrial products. The abilities of this powerful team give ZGSM unmatched technical strengths that allows it to have applied for over 50 worldwide patents.

Through collaboration with our partners and customers with innovative, reliable products and services, ZGSM is taking the world in a premium lighting experience.

## ES

Durante más de 17 años, ZGSM se ha dedicado a crear un entorno de iluminación eficiente, ecológico y de mejor calidad a través de diversos negocios de iluminación LED, semáforo, energía solar y sistemas de control inteligente.

Desde la creación, ZGSM ha sido rápidamente desarrollando su negocio en todo el mundo. En 2009, se tituló como empresas modelo de patentes, En 2009, fue galardonado como Empresa nacional de alta tecnología. En 2012, se convirtió en miembro de Sociedad de ingeniería iluminadora y Asociación de la industria de semiconductores en China.

El equipo de I + D (investigación y desarrollo) de ZGSM está compuesto por más de veinte miembros. Cada uno se graduó de universidades reconocidas en China y en el extranjero en las áreas de óptica, termodinámica, diseño industrial, ingeniería eléctrica, ingeniería de la información, artes, etc. Los diseñadores principales tienen mucha experiencia en importantes programas nacionales e internacionales para productos industriales. Las habilidades de este poderoso equipo le dan a ZGSM fortalezas técnicas inigualables que le permiten haber solicitado más de 50 patentes en todo el mundo.

A través de productos y servicios innovadores y confiables; en colaboración con nuestros socios y clientes, ZGSM está tomando el mundo en una experiencia de iluminación premium.

## FR

Depuis plus de 17 ans, ZGSM se consacre à la création d'un environnement d'éclairage de meilleure qualité, respectueux de l'environnement et efficace grâce à diverses activités d'éclairage à LED, de trafic, de système solaire et de système de contrôle intelligent.

Depuis sa création, ZGSM développe rapidement ses activités dans le monde entier. En 2009, elle a été classée entreprise modèle de brevets. En 2009, elle a été nommée entreprise nationale de haute technologie. En 2012, elle est devenue membre de l'Illuminating Engineering Society et de l'Association de l'industrie des semi-conducteurs en Chine.

L'équipe R&D de ZGSM se compose de plus de vingt membres, chacun diplômé d'universités renommées en Chine et à l'étranger dans les domaines de l'optique, de la thermodynamique, du design industriel, de l'électrotechnique, de l'ingénierie de l'information, de l'art, etc. Les concepteurs principaux ont une vaste expérience dans les programmes de produits industriels importants au pays et à l'étranger. Les capacités de cette puissante équipe confèrent à ZGSM une force technique inégalée, lui permettant d'avoir déposé plus de 50 brevets mondiaux.

Grâce aux produits et services innovants et fiables; à la collaboration avec nos partenaires et clients, ZGSM emmène le monde dans une expérience d'éclairage haut de gamme.



# CONTENTS

Factory  
Fábrica  
Usine



Test Equipments  
Equipo de prueba  
Équipements de Test



Certificates  
Certificados  
Certificats

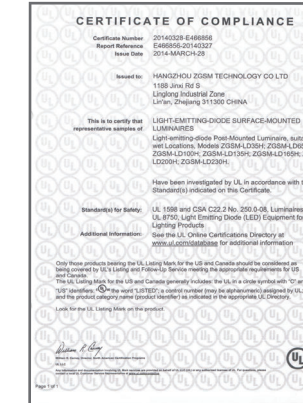
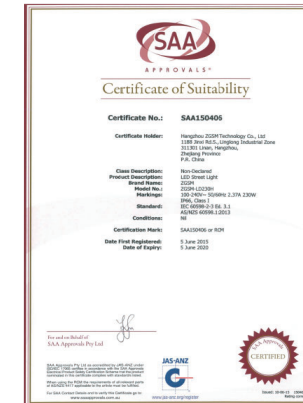

# TECHNICAL

TÉCNICO TECHNIQUE

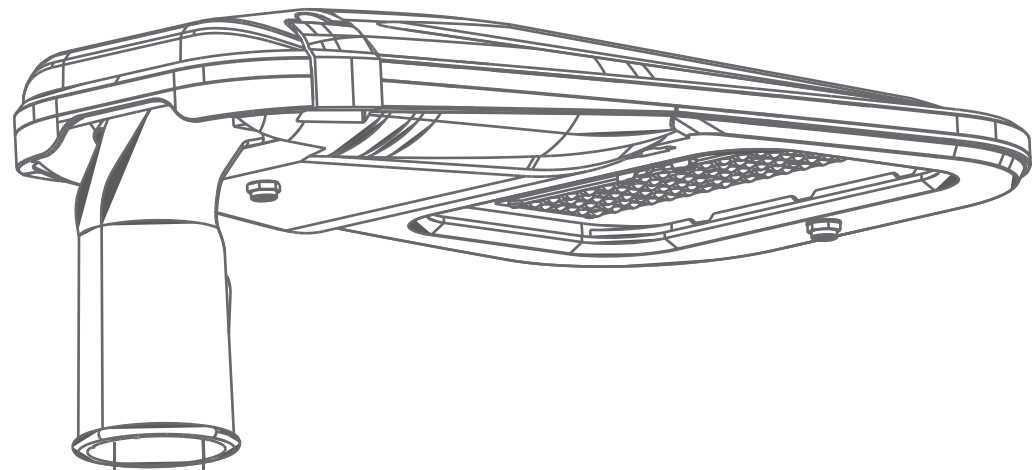

## CATALOGUE

CATÁLOGO CATALOGUE

# 2022



### LED Street Light Farola LED Lampadaire LED

H	03
H EVO	05
K	07
L	09
Kmini	11
Kmini2	13
N	15
Rifle <b>NEW</b>	17
Nova <b>NEW</b>	19

### LED High Bay Light LED Foco Industrial Luminaire Industriel LED

H	23
M	25
Helios <b>NEW</b>	27

### LED Flood Light LED Reflector Projecteur LED

HB	31
Stellar	33
Zoom <b>NEW</b>	35
Primo <b>NEW</b>	37

## CONTENTS

### LED Canopy Light Luminaria para Gasolinera Luminaire Encastré LED

A	41
H	43
Primo <b>NEW</b>	45

### LED Tunnel Light Luminaria LED para Túnel Luminaire de Tunnel LED

H	49
---	----

### LED Projector Light Luminaria LED para Estadio Éclairage de Stade LED

M	53
---	----

### Solar Street Light Luminaria Solar para Calle Lampadaire Solaire

PV3	57
-----	----

### LED Grow Light LED Luz de Cultivo Luminaire Horticole LED

Croplustre <b>NEW</b>	61
-----------------------	----





## LED STREET LIGHT FAROLA LED LAMPADAIRE LED

### EN

The projects for street light cover wide range, and for a demanding requirement for street light in the market, energy saving and easy maintenance are critical. ZGSM street lights take every aspect into consideration. Power ranges from 15W to 300W for different applications such as roadway, pathway, outside parking lot, rural road, etc. Multiple light distributions and intelligent controls available contribute significantly to reducing costs, delivering perfect illumination and avoiding light pollution. It will be amazing when choose ZGSM street lights family.

### ES

Los proyectos de alumbrado público cubren una amplia gama, y para un exigente requisito de alumbrado público en el mercado, el ahorro de energía y el fácil mantenimiento son fundamentales. Las farolas ZGSM tienen en cuenta todos los aspectos. La potencia varía de 15 W a 300 W para diferentes aplicaciones, como carreteras, caminos, estacionamientos exteriores, caminos rurales, etc. Las múltiples distribuciones de luz y los controles inteligentes disponibles contribuyen significativamente a reducir los costos, entregando una iluminación perfecta y evitando la contaminación lumínica. Será increíble cuando elija la familia de farolas ZGSM.

### FR

Les projets d'éclairage public couvrent une large gamme. Et pour répondre aux exigences élevées en éclairage public sur le marché, l'économie d'énergie et la facilité d'entretien sont essentielles. Les lampadaires ZGSM prennent tous les aspects en considération. Plage de puissance de 15W à 300W pour différentes applications telles que la route, le chemin, le parking extérieur, la route rurale, etc. Les distributions lumineuses multiples et les contrôles intelligents disponibles contribuent de manière significative à réduire les coûts, à fournir un éclairage parfait et à éviter la pollution lumineuse. Ce sera incroyable lorsque vous choisissez la famille de lampadaires ZGSM.



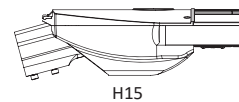
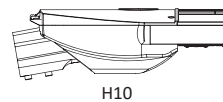
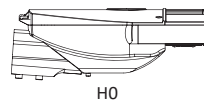

Horizontal /Horizontal /Horizontal

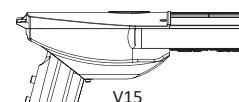
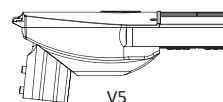
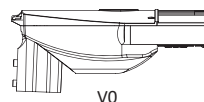

Vertical /Vertical /Vertical

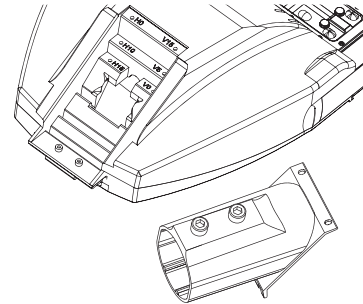

Fitter /Ajustador /Manche

**EN**  
Professional streetlight luminaire with LED light sources.  
**General Data**  
**Voltage:** 100-240 /277V 50 /60Hz  
**LED:** PHILIPS LUMILEDS  
**Driver:** MEANWELL /INVENTRONICS  
**Body:** High pressure die-cast aluminum  
**Colour:** Silver /Black  
**Cover:** Polycarbonate  
**Pole Diameter:** 60mm, 50mm is optional  
**Working Environment:** -40°C ~ +50°C; 10% ~ 90%RH  
**Protection Class:** Class I, Class II is optional  
**Optics:** Type I, Type II, Type III, Type V  
**Lifetime (L70):** 100, 000h  
**Available on request:** DALI, DIM 1-10V, OLC, Photocell, NTC

**ES**  
Luminaria de alumbrado público profesional con fuentes de luz LED.  
**Información General**  
**Voltaje:** 100-240 /277V 50 /60Hz  
**LED:** PHILIPS LUMILEDS  
**Conductor:** MEANWELL /INVENTRONICS  
**Cuerpo:** Aluminio fundido a alta presión  
**Color:** Plateado /negro  
**Cubierta:** Policarbonato  
**Diámetro del poste:** 60mm, 50mm es opcional  
**Ambiente de trabajo:** -40°C ~ +50°C; 10% ~ 90%RH  
**Clase de protección:** Clase I, Clase II es opcional  
**Óptica:** Tipo I, Tipo II, Tipo III, Tipo V  
**Vida útil (L70):** 100, 000h  
**Disponible:** DALI, DIM 1-10V, OLC, Fotocélula, NTC

**FR**  
Lampadaire professionnel avec sources lumineuses LED.  
**Données Générales**  
**Tension:** 100-240 /277V 50 /60Hz  
**LED:** PHILIPS LUMILEDS  
**Alimentation:** MEANWELL /INVENTRONICS  
**Corps:** Aluminium moulé sous pression  
**Couleur:** Argenté /Noir  
**Couverture:** Polycarbonate  
**Diamètre du Mât:** 60mm, 50mm est en option  
**Environnement de Travail:** -40°C ~ +50°C; 10% ~ 90%RH  
**Classe de Protection:** Classe I, Classe II est optionnelle  
**Optique:** Type I, Type II, Type III, Type V  
**Durée de Vie (L70):** 100, 000h  
**Disponible sur demande:** DALI, DIM 1-10V, OLC, Photocellule, NTC



# LED STREET LIGHT



## Regular Version | Versión regular | Version Régulière

ZGSM-LD40H4	40	5600	140	3000 /4000 /5000 /5700	>70	>0.95	480*370*200	6.3
ZGSM-LD50H5	50	6500	130	3000 /4000 /5000 /5700	>70	>0.95	480*370*200	6.3
ZGSM-LD60H6	60	7500	125	3000 /4000 /5000 /5700	>70	>0.95	480*370*200	6.3
ZGSM-LD80H4	80	11200	140	3000 /4000 /5000 /5700	>70	>0.95	555*370*200	7.3
ZGSM-LD100H5	100	13000	130	3000 /4000 /5000 /5700	>70	>0.95	555*370*200	7.3
ZGSM-LD120H6	120	15000	125	3000 /4000 /5000 /5700	>70	>0.95	555*370*200	7.3
ZGSM-LD120H4	120	16800	140	3000 /4000 /5000 /5700	>70	>0.95	630*370*200	8.6
ZGSM-LD150H5	150	19500	130	3000 /4000 /5000 /5700	>70	>0.95	630*370*200	8.6
ZGSM-LD180H6	180	22500	125	3000 /4000 /5000 /5700	>70	>0.95	630*370*200	8.6
ZGSM-LD160H4	160	22400	140	3000 /4000 /5000 /5700	>70	>0.95	705*370*200	9.6
ZGSM-LD200H5	200	26000	130	3000 /4000 /5000 /5700	>70	>0.95	705*370*200	9.6
ZGSM-LD240H6	240	30000	125	3000 /4000 /5000 /5700	>70	>0.95	705*370*200	9.6
ZGSM-LD200H4	200	28000	140	3000 /4000 /5000 /5700	>70	>0.95	780*370*200	10.6
ZGSM-LD240H5	240	31200	130	3000 /4000 /5000 /5700	>70	>0.95	780*370*200	10.6
ZGSM-LD300H6	300	37500	125	3000 /4000 /5000 /5700	>70	>0.95	780*370*200	10.6

## High Efficiency | Alta eficiencia | Haute Efficacité

ZGSM-LD40H4	40	6600	165	3000 /4000 /5000 /5700	>70	>0.95	480*370*200	6.3
ZGSM-LD50H5	50	8000	160	3000 /4000 /5000 /5700	>70	>0.95	480*370*200	6.3
ZGSM-LD60H6	60	9300	155	3000 /4000 /5000 /5700	>70	>0.95	480*370*200	6.3
ZGSM-LD80H4	80	13200	165	3000 /4000 /5000 /5700	>70	>0.95	555*370*200	7.3
ZGSM-LD100H5	100	16000	160	3000 /4000 /5000 /5700	>70	>0.95	555*370*200	7.3
ZGSM-LD120H6	120	18600	155	3000 /4000 /5000 /5700	>70	>0.95	555*370*200	7.3
ZGSM-LD120H4	120	19800	165	3000 /4000 /5000 /5700	>70	>0.95	630*370*200	8.6
ZGSM-LD150H5	150	24000	160	3000 /4000 /5000 /5700	>70	>0.95	630*370*200	8.6
ZGSM-LD180H6	180	27900	155	3000 /4000 /5000 /5700	>70	>0.95	630*370*200	8.6
ZGSM-LD160H4	160	26400	165	3000 /4000 /5000 /5700	>70	>0.95	705*370*200	9.6
ZGSM-LD200H5	200	32000	160	3000 /4000 /5000 /5700	>70	>0.95	705*370*200	9.6
ZGSM-LD240H6	240	37200	155	3000 /4000 /5000 /5700	>70	>0.95	705*370*200	9.6
ZGSM-LD200H4	200	33000	165	3000 /4000 /5000 /5700	>70	>0.95	780*370*200	10.6
ZGSM-LD240H5	240	38400	160	3000 /4000 /5000 /5700	>70	>0.95	780*370*200	10.6
ZGSM-LD300H6	300	46500	155	3000 /4000 /5000 /5700	>70	>0.95	780*370*200	10.6

Luminous flux tolerance +/- 5%. | Tolerancia de flujo luminoso +/- 5%. | Tolérance du flux lumineux +/- 5%.

## Optic | Óptica | Optique

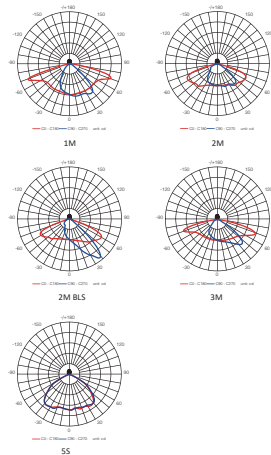

## Accessories | Accesorios | Accessoires

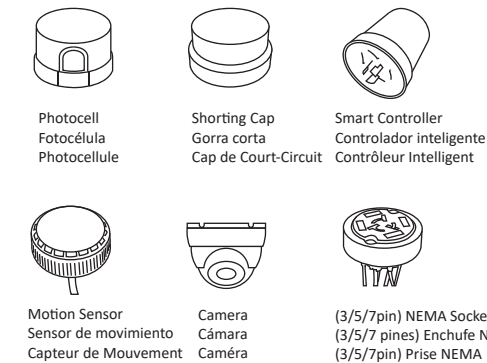

## Adapters | Adaptadores | Adaptateurs

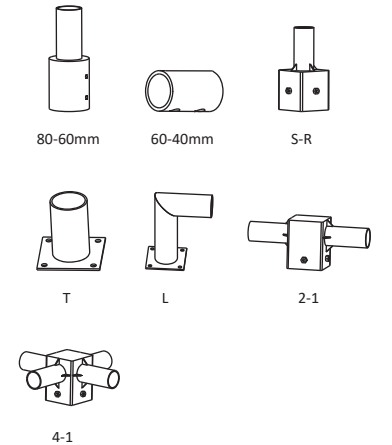





Adjustable tilt angle:  $\pm 0-5-10-15^\circ$   
 Ángulo de inclinación ajustable:  $\pm 0-5-10-15^\circ$   
 Angle d'inclinaison réglable :  $\pm 0-5-10-15^\circ$

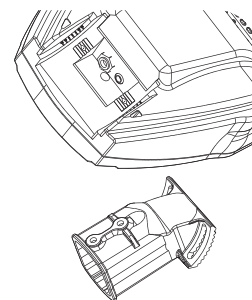
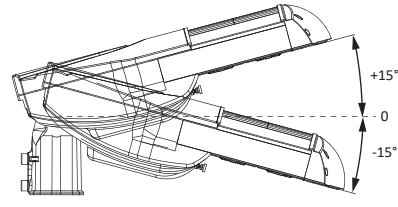
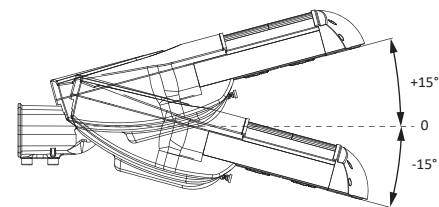

Horizontal /Horizontal /Horizontal

Vertical /Vertical /Vertical

Fitter /Ajustador /Manche

**EN**  
 Professional streetlight luminaire with LED light sources.  
**General Data**  
**Voltage:** 100-240 /277V 50 /60Hz  
**LED:** PHILIPS LUMILEDS  
**Driver:** MEANWELL /INVENTRONICS  
**Body:** High pressure die-cast aluminum  
**Colour:** Silver /Black  
**Cover:** Polycarbonate  
**Pole Diameter:** 60mm  
**Working Environment:** -40°C ~ +50°C; 10% ~ 90%RH  
**Protection Class:** Class I, Class II is optional  
**Optics:** Type I, Type II, Type III, Type V  
**Lifetime (L70):** 100,000h  
**Available on request:** DALI, DIM 1-10V, OLC, Photocell, Knife switch, NTC

**ES**  
 Luminaria de alumbrado público profesional con fuentes de luz LED.  
**Información General**  
**Voltaje:** 100-240 /277V 50 /60Hz  
**LED:** PHILIPS LUMILEDS  
**Conductor:** MEANWELL /INVENTRONICS  
**Cuerpo:** Aluminio fundido a alta presión  
**Color:** plateado /negro  
**Cubierta:** policarbonato  
**Diámetro del poste:** 60mm  
**Ambiente de trabajo:** -40°C ~ +50°C; 10% ~ 90%RH  
**Clase de protección:** Clase I, Clase II es opcional  
**Óptica:** Tipo I, Tipo II, Tipo III, Tipo V  
**Vida útil (L70):** 100,000h  
**Disponible:** DALI, DIM 1-10V, OLC, Fotocélula, Interruptor de cuchilla, NTC

**FR**  
 Lampadaire professionnel avec sources lumineuses LED.  
**Données Générales**  
**Tension:** 100-240 /277V 50 /60Hz  
**LED:** PHILIPS LUMILEDS  
**Alimentation:** MEANWELL /INVENTRONICS  
**Corps:** Aluminium moulé sous pression  
**Couleur:** Argenté / Noir  
**Couverture:** Polycarbonate  
**Diamètre du Mât:** 60mm  
**Environnement de Travail:** -40°C ~ +50°C; 10% ~ 90%RH  
**Classe de Protection:** Classe I, Classe II est optionnelle  
**Optique:** Type I, Type II, Type III, Type V  
**Durée de Vie (L70):** 100,000h  
**Disponible sur demande:** DALI, DIM 1-10V, OLC, Photocellule, Disjoncteur, NTC

CE  
CB

ENEC  
RoHS

IP66  
IK10

LM-79  
LM-80

TM-21  
LM-82

## LED STREET LIGHT



### Regular Version | Versión regular | Version Régulière

Model	Height (mm)	Power (W)	Beam Angle (°)	Light Output (lm)	Efficiency (lm/W)	CCT (K)	Ra/CRI	COSΦ PF	Dimensions (mm)	Weight (kg)
ZGSM-LD40H4+	40	5600	140	3000 /4000 /5000 /5700	>70	>0.95	520*370*200	7.1		
ZGSM-LD50H5+	50	6500	130	3000 /4000 /5000 /5700	>70	>0.95	520*370*200	7.1		
ZGSM-LD60H6+	60	7500	125	3000 /4000 /5000 /5700	>70	>0.95	520*370*200	7.1		
ZGSM-LD80H4+	80	11200	140	3000 /4000 /5000 /5700	>70	>0.95	595*370*200	8.1		
ZGSM-LD100H5+	100	13000	130	3000 /4000 /5000 /5700	>70	>0.95	595*370*200	8.1		
ZGSM-LD120H6+	120	15000	125	3000 /4000 /5000 /5700	>70	>0.95	595*370*200	8.1		
ZGSM-LD120H4+	120	16800	140	3000 /4000 /5000 /5700	>70	>0.95	670*370*200	9.4		
ZGSM-LD150H5+	150	19500	130	3000 /4000 /5000 /5700	>70	>0.95	670*370*200	9.4		
ZGSM-LD180H6+	180	22500	125	3000 /4000 /5000 /5700	>70	>0.95	670*370*200	9.4		
ZGSM-LD160H4+	160	22400	140	3000 /4000 /5000 /5700	>70	>0.95	745*370*200	10.4		
ZGSM-LD200H5+	200	26000	130	3000 /4000 /5000 /5700	>70	>0.95	745*370*200	10.4		
ZGSM-LD240H6+	240	30000	125	3000 /4000 /5000 /5700	>70	>0.95	745*370*200	10.4		
ZGSM-LD200H4+	200	28000	140	3000 /4000 /5000 /5700	>70	>0.95	820*370*200	11.4		
ZGSM-LD240H5+	240	31200	130	3000 /4000 /5000 /5700	>70	>0.95	820*370*200	11.4		
ZGSM-LD300H6+	300	37500	125	3000 /4000 /5000 /5700	>70	>0.95	820*370*200	11.4		

### High Efficiency | Alta eficiencia | Haute Efficacité

Model	Height (mm)	Power (W)	Beam Angle (°)	Light Output (lm)	Efficiency (lm/W)	CCT (K)	Ra/CRI	COSΦ PF	Dimensions (mm)	Weight (kg)
ZGSM-LD40H4+	40	6600	165	3000 /4000 /5000 /5700	>70	>0.95	520*370*200	7.1		
ZGSM-LD50H5+	50	8000	160	3000 /4000 /5000 /5700	>70	>0.95	520*370*200	7.1		
ZGSM-LD60H6+	60	9300	155	3000 /4000 /5000 /5700	>70	>0.95	520*370*200	7.1		
ZGSM-LD80H4+	80	13200	165	3000 /4000 /5000 /5700	>70	>0.95	595*370*200	8.1		
ZGSM-LD100H5+	100	16000	160	3000 /4000 /5000 /5700	>70	>0.95	595*370*200	8.1		
ZGSM-LD120H6+	120	18600	155	3000 /4000 /5000 /5700	>70	>0.95	595*370*200	8.1		
ZGSM-LD120H4+	120	19800	165	3000 /4000 /5000 /5700	>70	>0.95	670*370*200	9.4		
ZGSM-LD150H5+	150	24000	160	3000 /4000 /5000 /5700	>70	>0.95	670*370*200	9.4		
ZGSM-LD180H6+	180	27900	155	3000 /4000 /5000 /5700	>70	>0.95	670*370*200	9.4		
ZGSM-LD160H4+	160	26400	165	3000 /4000 /5000 /5700	>70	>0.95	745*370*200	10.4		
ZGSM-LD200H5+	200	32000	160	3000 /4000 /5000 /5700	>70	>0.95	745*370*200	10.4		
ZGSM-LD240H6+	240	37200	155	3000 /4000 /5000 /5700	>70	>0.95	745*370*200	10.4		
ZGSM-LD200H4+	200	33000	165	3000 /4000 /5000 /5700	>70	>0.95	820*370*200	11.4		
ZGSM-LD240H5+	240	38400	160	3000 /4000 /5000 /5700	>70	>0.95	820*370*200	11.4		
ZGSM-LD300H6+	300	46500	155	3000 /4000 /5000 /5700	>70	>0.95	820*370*200	11.4		

Luminous flux tolerance +/- 5%. | Tolerancia de flujo luminoso +/- 5% | Tolérance du flux lumineux +/- 5%

### Optic | Óptica | Optique

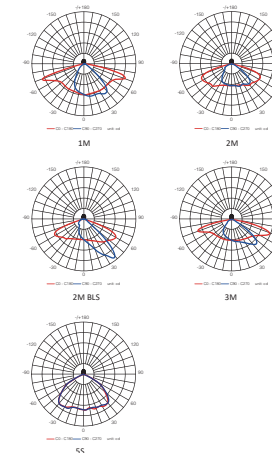

### Accessories | Accesorios | Accessoires

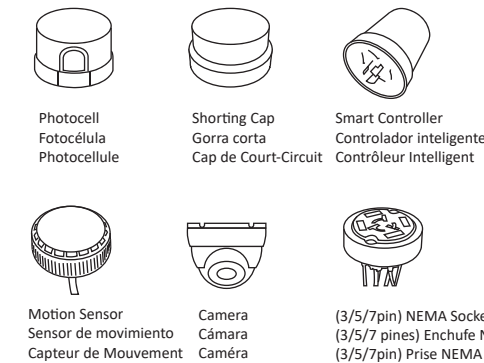

### Adapters | Adaptadores | Adaptateurs

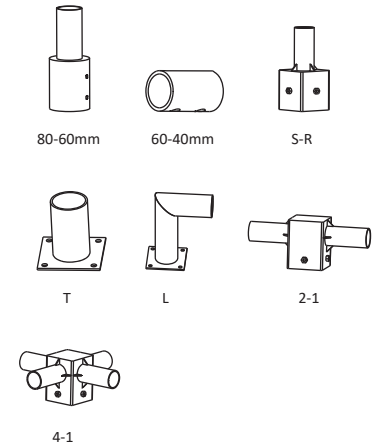



Adjustable tilt angle:  $\pm 0-5-10-15^\circ$   
 Ángulo de inclinación ajustable:  $\pm 0-5-10-15^\circ$   
 Angle d'inclinaison réglable :  $\pm 0-5-10-15^\circ$

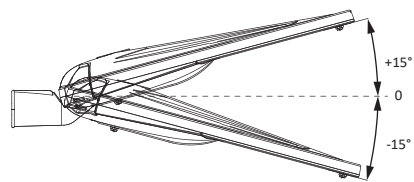

Horizontal /Horizontal /Horizontal

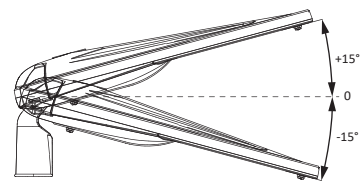

Vertical /Vertical /Vertical

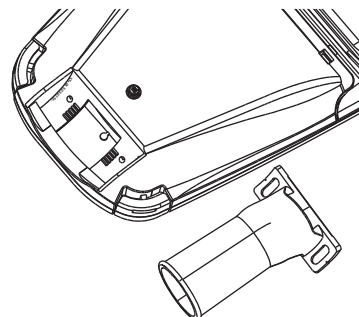

Fitter /Ajustador /Manche

**EN**  
 Professional streetlight luminaire with LED light sources.  
**General Data**  
**Voltage:** 100-240 /277V 50 /60Hz  
**LED:** PHILIPS LUMILEDS  
**Driver:** MEANWELL /INVENTRONICS  
**Body:** High pressure die-cast aluminum  
**Colour:** Deep grey /Light grey  
**Cover:** Toughened glass and Polycarbonate  
**Pole Diameter:** 60mm, 50mm is optional  
**Working Environment:** -40°C ~ +50°C; 10% ~ 90%RH  
**Protection Class:** Class I, Class II is optional  
**Optics:** Type I, Type II, Type III, Type V  
**Lifetime (L70):** 100,000h  
**Available on request:** DALI, DIM 1-10V, OLC, Photocell, Knife switch, NTC

**ES**  
 Luminaria de alumbrado público profesional con fuentes de luz LED.  
**Información General**  
**Voltaje:** 100-240 /277V 50 /60Hz  
**LED:** PHILIPS LUMILEDS  
**Conductor:** MEANWELL /INVENTRONICS  
**Cuerpo:** Aluminio fundido a alta presión  
**Color:** gris oscuro /gris claro  
**Cubierta:** vidrio templado y policarbonato  
**Diámetro del poste:** 60mm, 50mm es opcional  
**Ambiente de trabajo:** -40°C ~ +50°C; 10% ~ 90%RH  
**Clase de protección:** Clase I, Clase II es opcional  
**Óptica:** Tipo I, Tipo II, Tipo III, Tipo V  
**Vida útil (L70):** 100,000h  
**Disponible:** DALI, DIM 1-10V, OLC, Fotocélula, Interruptor de cuchilla, NTC

**FR**  
 Lampadaire professionnel avec sources lumineuses LED.  
**Données Générales**  
**Tension:** 100-240 /277V 50 /60Hz  
**LED:** PHILIPS LUMILEDS  
**Alimentation:** MEANWELL /INVENTRONICS  
**Corps:** Aluminium moulé sous pression  
**Couleur:** Gris foncé /Gris clair  
**Couverture:** Verre trempé et polycarbonate  
**Diamètre du Mât:** 60mm, 50mm est en option  
**Environnement de Travail:** -40°C ~ +50°C; 10% ~ 90%RH  
**Classe de Protection:** Classe I, Classe II est optionnelle  
**Optique:** Type I, Type II, Type III, Type V  
**Durée de Vie (L70):** 100,000h  
**Disponible sur demande:** DALI, DIM 1-10V, OLC, Photocellule, Disjoncteur, NTC

CE  
CB

ENEC  
RoHS

IP66  
IK08

LM-79  
LM-80

TM-21  
LM-82

# LED STREET LIGHT



## Regular Version | Versión regular | Version Régulière

Model	Height (mm)	Power (W)	Beam Angle (°)	Light Output (lm)	Efficiency (lm/W)	CCT (K)	Ra/CRI	COSΦ PF	Dimensions (mm)	Weight (kg)
ZGSM-LD25KS	25	3125	125	3000 /4000 /5000 /5700	>70	>0.95	670*310*170	6.8		
ZGSM-LD35KS	35	4375	125	3000 /4000 /5000 /5700	>70	>0.95	670*310*170	6.9		
ZGSM-LD55KS	55	6875	125	3000 /4000 /5000 /5700	>70	>0.95	670*310*170	7.0		
ZGSM-LD60KM	60	7800	130	3000 /4000 /5000 /5700	>70	>0.95	785*420*160	9.5		
ZGSM-LD90KM	90	11700	130	3000 /4000 /5000 /5700	>70	>0.95	785*420*160	10.1		
ZGSM-LD120KM	120	15600	130	3000 /4000 /5000 /5700	>70	>0.95	785*420*160	10.2		
ZGSM-LD120KL	120	15600	130	3000 /4000 /5000 /5700	>70	>0.95	915*495*225	14.5		
ZGSM-LD150KL	150	19500	130	3000 /4000 /5000 /5700	>70	>0.95	915*495*225	14.5		
ZGSM-LD180KL	180	23400	130	3000 /4000 /5000 /5700	>70	>0.95	915*495*225	14.6		
ZGSM-LD200KL	200	26000	130	3000 /4000 /5000 /5700	>70	>0.95	915*495*225	14.7		

## High Efficiency | Alta eficiencia | Haute Efficacité

Model	Height (mm)	Power (W)	Beam Angle (°)	Light Output (lm)	Efficiency (lm/W)	CCT (K)	Ra/CRI	COSΦ PF	Dimensions (mm)	Weight (kg)
ZGSM-LD25KS	25	3625	145	3000 /4000 /5000 /5700	>70	>0.95	670*310*170	6.8		
ZGSM-LD35KS	35	5075	145	3000 /4000 /5000 /5700	>70	>0.95	670*310*170	6.9		
ZGSM-LD55KS	55	7975	145	3000 /4000 /5000 /5700	>70	>0.95	670*310*170	7.0		
ZGSM-LD60KM	60	9000	150	3000 /4000 /5000 /5700	>70	>0.95	785*420*160	9.5		
ZGSM-LD90KM	90	13500	150	3000 /4000 /5000 /5700	>70	>0.95	785*420*160	10.1		
ZGSM-LD120KM	120	18000	150	3000 /4000 /5000 /5700	>70	>0.95	785*420*160	10.2		
ZGSM-LD120KL	120	18000	150	3000 /4000 /5000 /5700	>70	>0.95	915*495*225	14.5		
ZGSM-LD150KL	150	22500	150	3000 /4000 /5000 /5700	>70	>0.95	915*495*225	14.5		
ZGSM-LD180KL	180	27000	150	3000 /4000 /5000 /5700	>70	>0.95	915*495*225	14.6		
ZGSM-LD200KL	200	30000	150	3000 /4000 /5000 /5700	>70	>0.95	915*495*225	14.7		

Luminous flux tolerance +/- 5% | Tolerancia de flujo luminoso +/- 5% | Tolérance de flux lumineux +/- 5%

## Optic | Óptica | Optique

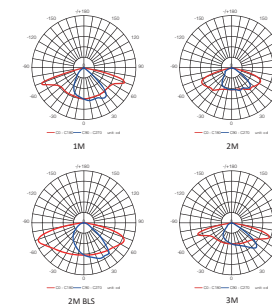

## Accessories | Accesorios | Accessoires



Photocell  
Fotocélula  
Photocellule



Shorting Cap  
Gorra corta  
Cap de Court-Circuit



Smart Controller  
Controlador inteligente  
Contrôleur Intelligent



Motion Sensor  
Sensor de movimiento  
Capteur de Mouvement



Camera  
Cámara  
Caméra



(3/5/7pin) NEMA Socket  
(3/5/7 pines) Enchufe NEMA  
(3/5/7pin) Prise NEMA

## Adapters | Adaptadores | Adaptateurs



80-60mm



60-40mm



S-R



T

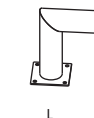

L



2-1



4-1





### Flexible mounted | Montaje flexible | Installation flexible

- A: Post Top Mounted / A: Puesto superior montado / A: Installation Sur Poteau
- B: Pendant Mounted / B: Colgante Montado / B: Installation Pendante
- C: Side Entry Mounted / C: Entrada lateral montada / C: Installation Latérale
- D: Suspended Mounted / D: Suspendido montado / D: Installation Pendue

Order Reference  
Pedir Referencia  
Référéce de l'Achat  
ZGSM-LD120LM **A**

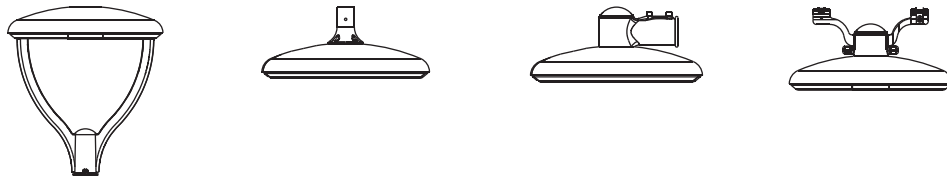

**EN**  
Professional streetlight luminaire with LED light sources.  
**General Data**  
Voltage: 100-240 /277V 50 /60Hz  
LED: PHILIPS LUMILEDS  
Driver: MEANWELL /INVENTRONICS  
Body: High pressure die-cast aluminum  
Colour: Deep grey  
Cover: Toughened glass and Polycarbonate  
Pole Diameter: 60mm  
Working Environment: -40°C ~ +50°C; 10% ~ 90%RH  
Protection Class: Class I, Class II is optional  
Optics: Type I, Type II, Type III, Type V  
Lifetime (L70): 100,000h  
Available on request: DALI, DIM 1-10V, OLC, Photocell, NTC

**ES**  
Luminaria de alumbrado público profesional con fuentes de luz LED.  
**Información General**  
Voltaje: 100-240 /277V 50 /60Hz  
LED: PHILIPS LUMILEDS  
Conductor: MEANWELL /INVENTRONICS  
Cuerpo: Aluminio fundido a alta presión  
Color: Gris oscuro  
Cubierta: Vidrio templado y policarbonato  
Diámetro del poste: 60mm  
Ambiente de trabajo: -40°C ~ +50°C; 10% ~ 90%RH  
Clase de protección: Clase I, Clase II es opcional  
Óptica: Tipo I, Tipo II, Tipo III, Tipo V  
Vida útil (L70): 100,000h  
Disponible: DALI, DIM 1-10V, OLC, Fotocélula, NTC

**FR**  
Lampadaire professionnel avec sources lumineuses LED.  
**Données Générales**  
Tension: 100-240 /277V 50 /60Hz  
LED: PHILIPS LUMILEDS  
Alimentation: MEANWELL /INVENTRONICS  
Corps: Aluminium moulé sous pression  
Couleur: Gris foncé  
Couverture: Verre trempé et Polycarbonate  
Diamètre du Mât: 60mm  
Environnement de Travail: -40°C ~ +50°C; 10% ~ 90%RH  
Classe de Protection: Classe I, Classe II est optionnelle  
Optique: Type I, Type II, Type III, Type V  
Durée de Vie (L70): 100,000h  
Disponible sur demande: DALI, DIM 1-10V, OLC, Photocellule, NTC

CE CB ENEC RoHS IP66 IK08 LM-79 LM-80 TM-21 LM-82

## LED STREET LIGHT



### Regular Version | Versión regular | Version Régulière

ZGSM-LD27LM	27	3510	130	3000 /4000 /5000 /5700	>70	>0.95	495*495*170	10.1
ZGSM-LD37LM	37	4810	130	3000 /4000 /5000 /5700	>70	>0.95	495*495*170	10.1
ZGSM-LD56LM	56	7280	130	3000 /4000 /5000 /5700	>70	>0.95	495*495*170	10.1
ZGSM-LD70LM	70	9100	130	3000 /4000 /5000 /5700	>70	>0.95	495*495*170	10.2
ZGSM-LD90LM	90	11700	130	3000 /4000 /5000 /5700	>70	>0.95	495*495*170	10.5
ZGSM-LD120LM	120	15000	125	3000 /4000 /5000 /5700	>70	>0.95	495*495*170	10.5

### High Efficiency | Alta eficiencia | Haute Efficacité

ZGSM-LD27LM	27	4050	150	3000 /4000 /5000 /5700	>70	>0.95	495*495*170	10.1
ZGSM-LD37LM	37	5550	150	3000 /4000 /5000 /5700	>70	>0.95	495*495*170	10.1
ZGSM-LD56LM	56	8400	150	3000 /4000 /5000 /5700	>70	>0.95	495*495*170	10.1
ZGSM-LD70LM	70	10500	150	3000 /4000 /5000 /5700	>70	>0.95	495*495*170	10.2
ZGSM-LD90LM	90	13500	150	3000 /4000 /5000 /5700	>70	>0.95	495*495*170	10.5
ZGSM-LD120LM	120	17400	145	3000 /4000 /5000 /5700	>70	>0.95	495*495*170	10.5

Luminous flux tolerance +/- 5%. | Tolerancia de flujo luminoso +/- 5% | Tolérance du flux lumineux +/- 5%

### Optic | Óptica | Optique

★ B | C | D

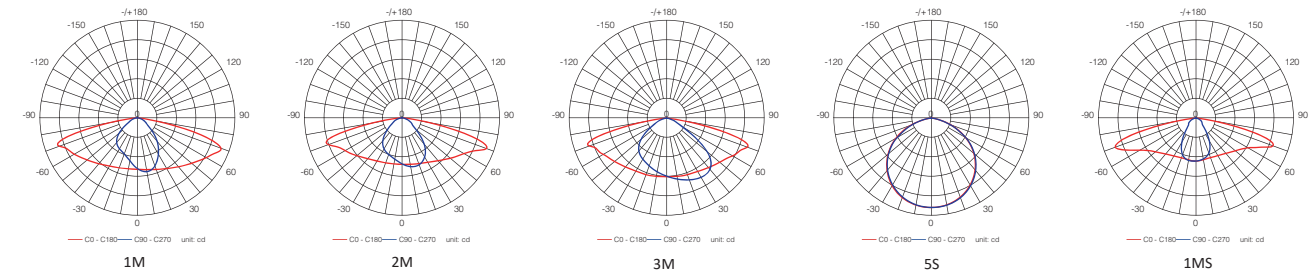

★ A

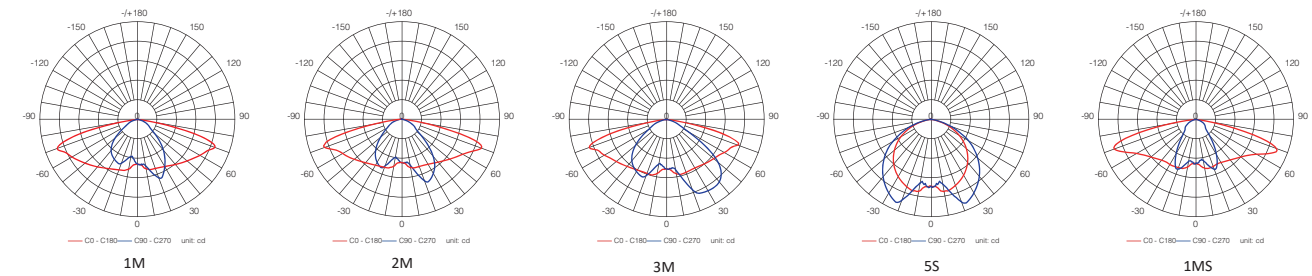

### Accessories | Accesorios | Accessoires

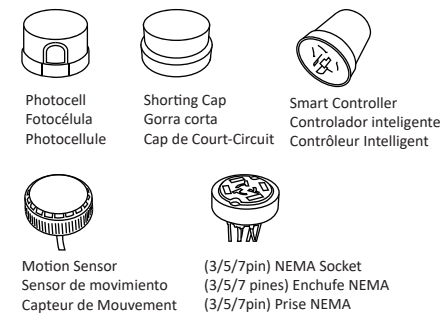

### Adapters | Adaptadores | Adaptateurs

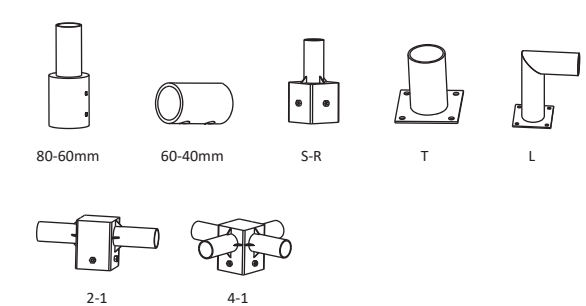



## LED STREET LIGHT



### Regular Version | Versión regular | Version Régulière

Model	28	38	57	20	20	30	30	40	40	50
ZGSM-LD28Kmini	28	3976	142	3000 / 4000 / 5000 / 5700	>70	>0.95	465*200*100	2.60		
ZGSM-LD38Kmini	38	5168	136	3000 / 4000 / 5000 / 5700	>70	>0.95	465*200*100	2.60		
ZGSM-LD57Kmini	57	7809	137	3000 / 4000 / 5000 / 5700	>70	>0.95	465*200*100	2.70		
ZGSM-LD20Kmini	20	2920	146	3000 / 4000 / 5000 / 5700	>70	>0.95	465*200*100	2.60		
ZGSM-LD20Kmini+	20	3120	156	3000 / 4000 / 5000 / 5700	>70	>0.95	465*200*100	2.60		
ZGSM-LD30Kmini	30	4200	140	3000 / 4000 / 5000 / 5700	>70	>0.95	465*200*100	2.70		
ZGSM-LD30Kmini+	30	4530	151	3000 / 4000 / 5000 / 5700	>70	>0.95	465*200*100	2.70		
ZGSM-LD40Kmini	40	5600	140	3000 / 4000 / 5000 / 5700	>70	>0.95	465*200*100	2.70		
ZGSM-LD40Kmini+	40	5880	147	3000 / 4000 / 5000 / 5700	>70	>0.95	465*200*100	2.70		
ZGSM-LD50Kmini	50	7100	142	3000 / 4000 / 5000 / 5700	>70	>0.95	465*200*100	2.70		

### High Efficiency | Alta eficiencia | Haute Efficacité

Model	26	36	53	20	20	30	40	40	50
ZGSM-LD28Kmini	26	3926	151	3000 / 4000 / 5000 / 5700	>70	>0.95	465*200*100	2.60	
ZGSM-LD38Kmini	36	5256	146	3000 / 4000 / 5000 / 5700	>70	>0.95	465*200*100	2.60	
ZGSM-LD57Kmini	53	7632	144	3000 / 4000 / 5000 / 5700	>70	>0.95	465*200*100	2.70	
ZGSM-LD20Kmini	20	3080	154	3000 / 4000 / 5000 / 5700	>70	>0.95	465*200*100	2.60	
ZGSM-LD20Kmini+	20	3200	160	3000 / 4000 / 5000 / 5700	>70	>0.95	465*200*100	2.60	
ZGSM-LD30Kmini	30	4620	154	3000 / 4000 / 5000 / 5700	>70	>0.95	465*200*100	2.70	
ZGSM-LD40Kmini	40	6000	150	3000 / 4000 / 5000 / 5700	>70	>0.95	465*200*100	2.70	
ZGSM-LD50Kmini	50	7500	150	3000 / 4000 / 5000 / 5700	>70	>0.95	465*200*100	2.70	

Luminous flux tolerance +/- 5%. | Tolerancia de flujo luminoso +/- 5% | Tolérance du flux lumineux +/- 5%

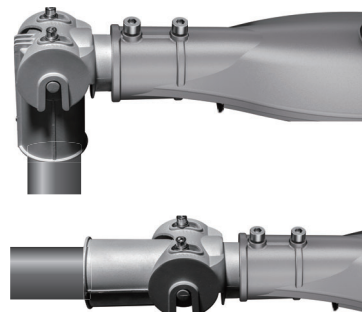
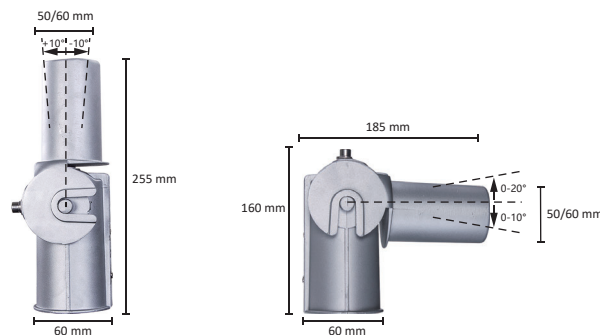

**EN**  
Professional streetlight luminaire with LED light sources.  
**General Data**  
**Voltage:** 100-240 / 277V 50 / 60Hz  
**LED:** PHILIPS LUMILEDS  
**Driver:** MEANWELL / INVENTRONICS  
**Body:** High pressure die-cast aluminum  
**Colour:** Deep grey  
**Cover:** Polycarbonate  
**Pole Diameter:** 60mm, 50mm is optional  
**Working Environment:** -40°C ~ +50°C; 10% ~ 90%RH  
**Protection Class:** Class I, Class II is optional  
**Optics:** Type II  
**Lifetime (L70):** 100, 000h  
**Available on request:** DALI, DIM 1-10V, OLC, Photocell, NTC

**ES**  
Luminaria de alumbrado público profesional con fuentes de luz LED.  
**Información General**  
**Voltaje:** 100-240 / 277V 50 / 60Hz  
**LED:** PHILIPS LUMILEDS  
**Conductor:** MEANWELL / INVENTRONICS  
**Cuerpo:** Aluminio fundido a alta presión  
**Color:** Gris oscuro  
**Cubierta:** Policarbonato  
**Diámetro del poste:** 60mm, 50mm es opcional  
**Ambiente de trabajo:** -40°C ~ +50°C; 10% ~ 90%RH  
**Clase de protección:** Clase I, Clase II es opcional  
**Óptica:** Tipoll  
**Vida útil (L70):** 100, 000h  
**Disponible:** DALI, DIM 1-10V, OLC, Fotocélula, NTC

**FR**  
Lampadaire professionnel avec sources lumineuses LED.  
**Données Générales**  
**Tension:** 100-240 / 277V 50 / 60Hz  
**LED:** PHILIPS LUMILEDS  
**Alimentation:** MEANWELL / INVENTRONICS  
**Corps:** Aluminium moulé sous pression  
**Couleur:** Gris foncé  
**Couverture:** Polycarbonate  
**Diamètre du Mât:** 60mm, 50mm est en option  
**Environnement de Travail:** -40°C ~ +50°C; 10% ~ 90%RH  
**Classe de Protection:** Classe I, Classe II est optionnelle  
**Optique:** Type II  
**Durée de Vie (L70):** 100, 000h  
**Disponible sur demande:** DALI, DIM 1-10V, OLC, Photocellule, NTC

### Optic | Óptica | Optique

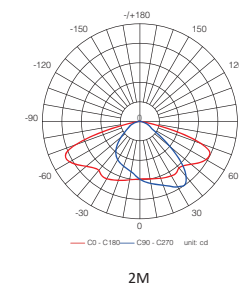

2M

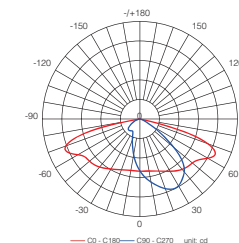

2M BLS

### Accessories | Accesorios | Accessoires

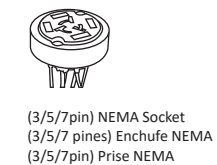
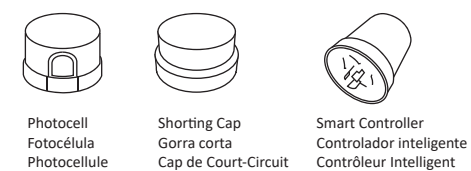

### Adapters | Adaptadores | Adaptateurs

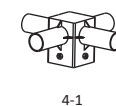
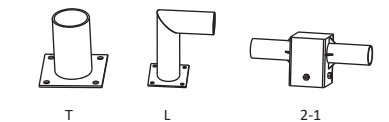



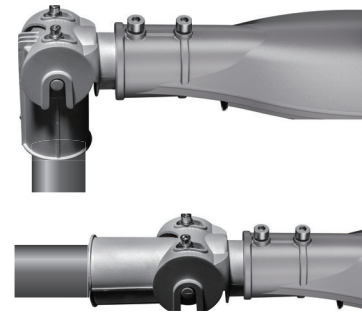
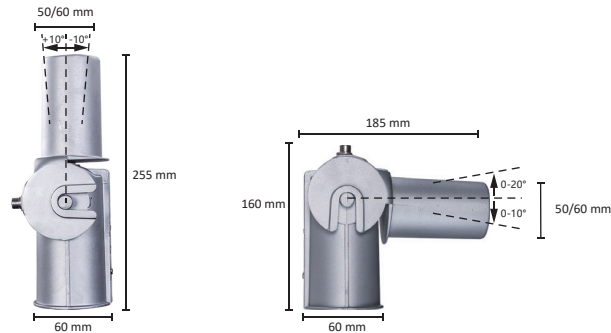

**EN**  
Professional streetlight luminaire with LED light sources.

**General Data**  
Voltage: 100-240 /277V 50 /60Hz  
LED: PHILIPS LUMILEDS  
Driver: MEANWELL /INVENTRONICS  
Body: High pressure die-cast aluminum  
Colour: Deep grey  
Cover: Polycarbonate  
Pole Diameter: 60mm  
Working Environment: -40°C ~ +50°C; 10% ~ 90%RH  
Protection Class: Class I, Class II is optional  
Optics: Type II  
Lifetime (L70): 100,000h  
Available on request: DALI, DIM 1-10V, OLC, Photocell, NTC

**ES**  
Luminaria de alumbrado público profesional con fuentes de luz LED.

**Información General**  
Voltaje: 100-240 /277V 50 /60Hz  
LED: PHILIPS LUMILEDS  
Conductor: MEANWELL /INVENTRONICS  
Cuerpo: Aluminio fundido a alta presión  
Color: Gris oscuro  
Cubierta: Policarbonato  
Diámetro del poste: 60mm  
Ambiente de trabajo: -40°C ~ +50°C; 10% ~ 90%RH  
Clase de protección: Clase I, Clase II es opcional  
Óptica: Tipo II  
Vida útil (L70): 100,000h  
Disponible: DALI, DIM 1-10V, OLC, Fotorcélula, NTC

**FR**  
Lampadaire professionnel avec sources lumineuses LED.

**Données Générales**  
Tension: 100-240 /277V 50 /60Hz  
LED: PHILIPS LUMILEDS  
Alimentation: MEANWELL /INVENTRONICS  
Corps: Aluminium moulé sous pression  
Couleur: Gris foncé  
Couverture: Polycarbonate  
Diamètre du Mât: 60mm  
Environnement de Travail: -40°C ~ +50°C; 10% ~ 90%RH  
Classe de Protection: Classe I, Classe II est optionnelle  
Optique: Type II  
Durée de Vie (L70): 100,000h  
Disponible sur demande: DALI, DIM 1-10V, OLC, Photocellule, NTC

CE CB ENEC RoHS IP66 IK10 LM-79 LM-80 TM-21 LM-82

## LED STREET LIGHT



### Regular Version | Versión regular | Version Régulière

Model	Length (mm)	Power (W)	Beam Angle (°)	Light Output (lm)	Efficiency (lm/W)	CCT (K)	Ra/CRI	COSΦ PF	Dimensions (mm)	Weight (kgs)
ZGSM-LD60Kmini2	60	8400	140	3000 /4000 /5000 /5700	>70	>0.95	735*195*120	4.20		
ZGSM-LD60Kmini2+	60	9180	153	3000 /4000 /5000 /5700	>70	>0.95	735*195*120	4.20		
ZGSM-LD70Kmini2	70	9450	135	3000 /4000 /5000 /5700	>70	>0.95	735*195*120	4.20		
ZGSM-LD70Kmini2+	70	10710	153	3000 /4000 /5000 /5700	>70	>0.95	735*195*120	4.20		
ZGSM-LD80Kmini2	80	11520	144	3000 /4000 /5000 /5700	>70	>0.95	735*195*120	4.20		
ZGSM-LD80Kmini2+	80	12240	153	3000 /4000 /5000 /5700	>70	>0.95	735*195*120	4.20		
ZGSM-LD90Kmini2	90	12600	140	3000 /4000 /5000 /5700	>70	>0.95	735*195*120	4.20		
ZGSM-LD90Kmini2+	90	13500	150	3000 /4000 /5000 /5700	>70	>0.95	735*195*120	4.20		
ZGSM-LD100Kmini2	100	13700	137	3000 /4000 /5000 /5700	>70	>0.95	735*195*120	4.20		
ZGSM-LD100Kmini2+	100	14600	146	3000 /4000 /5000 /5700	>70	>0.95	735*195*120	4.20		
ZGSM-LD110Kmini2	110	15730	143	3000 /4000 /5000 /5700	>70	>0.95	735*195*120	4.42		
ZGSM-LD120Kmini2	120	16800	140	3000 /4000 /5000 /5700	>70	>0.95	735*195*120	4.42		
ZGSM-LD130Kmini2	130	17680	136	3000 /4000 /5000 /5700	>70	>0.95	735*195*120	4.42		
ZGSM-LD150Kmini2	150	19500	130	3000 /4000 /5000 /5700	>70	>0.95	735*195*120	4.42		

### High Efficiency | Alta eficiencia | Haute Efficacité

Model	Length (mm)	Power (W)	Beam Angle (°)	Light Output (lm)	Efficiency (lm/W)	CCT (K)	Ra/CRI	COSΦ PF	Dimensions (mm)	Weight (kgs)
ZGSM-LD60Kmini2	60	9180	153	3000 /4000 /5000 /5700	>70	>0.95	735*195*120	4.20		
ZGSM-LD60Kmini2+	60	9780	163	3000 /4000 /5000 /5700	>70	>0.95	735*195*120	4.20		
ZGSM-LD70Kmini2	70	10500	150	3000 /4000 /5000 /5700	>70	>0.95	735*195*120	4.20		
ZGSM-LD70Kmini2+	70	11200	160	3000 /4000 /5000 /5700	>70	>0.95	735*195*120	4.20		
ZGSM-LD80Kmini2	80	12480	156	3000 /4000 /5000 /5700	>70	>0.95	735*195*120	4.20		
ZGSM-LD80Kmini2+	80	12800	160	3000 /4000 /5000 /5700	>70	>0.95	735*195*120	4.20		
ZGSM-LD90Kmini2	90	13770	153	3000 /4000 /5000 /5700	>70	>0.95	735*195*120	4.20		
ZGSM-LD90Kmini2+	90	14130	157	3000 /4000 /5000 /5700	>70	>0.95	735*195*120	4.20		
ZGSM-LD100Kmini2	100	15000	150	3000 /4000 /5000 /5700	>70	>0.95	735*195*120	4.20		
ZGSM-LD100Kmini2+	100	15400	154	3000 /4000 /5000 /5700	>70	>0.95	735*195*120	4.20		
ZGSM-LD110Kmini2	110	17050	155	3000 /4000 /5000 /5700	>70	>0.95	735*195*120	4.42		
ZGSM-LD120Kmini2	120	18240	152	3000 /4000 /5000 /5700	>70	>0.95	735*195*120	4.42		
ZGSM-LD130Kmini2	130	19500	150	3000 /4000 /5000 /5700	>70	>0.95	735*195*120	4.42		
ZGSM-LD150Kmini2	150	21000	140	3000 /4000 /5000 /5700	>70	>0.95	735*195*120	4.42		

Luminous flux tolerance +/- 5% | Tolerancia de flujo luminoso +/- 5% | Tolérance de flux lumineux +/- 5%

### Optic | Óptica | Optique

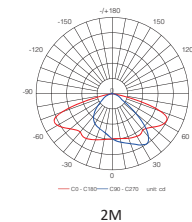

2M

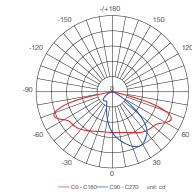

2M BLS

### Accessories | Accesorios | Accessoires

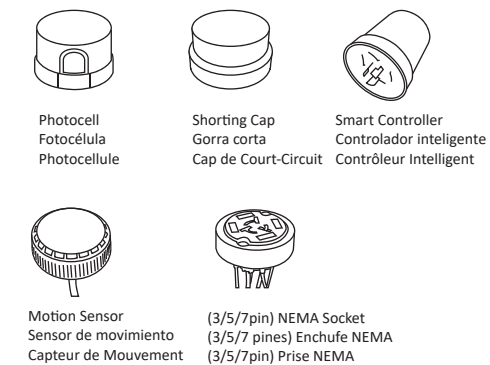

### Adapters | Adaptadores | Adaptateurs

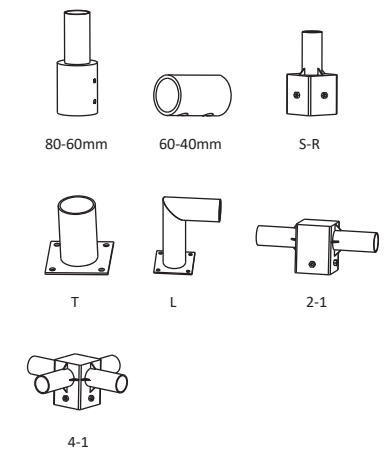

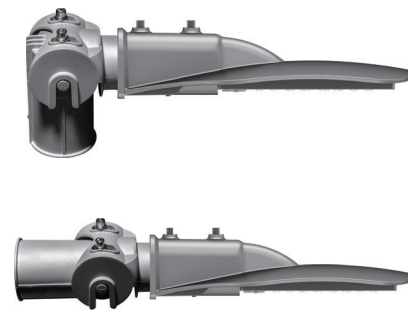
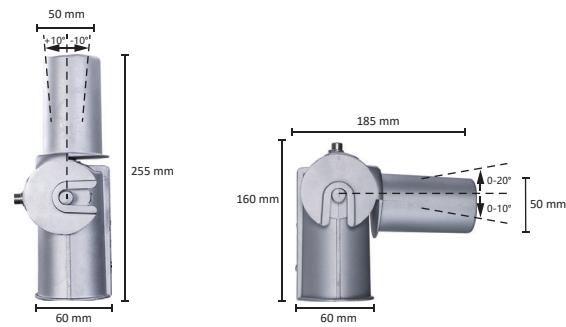

**EN**  
Professional streetlight luminaire with LED light sources.  
**General Data**  
**Voltage:** DC 48V  
**LED:** PHILIPS LUMILEDS  
**Driver:** N/A  
**Body:** High pressure die-cast aluminum  
**Colour:** Deep grey  
**Cover:** Polycarbonate  
**Pole Diameter:** 50mm  
**Working Environment:** -40°C ~ +50°C; 10% ~ 90%RH  
**Protection Class:** Class III, Class I and II are optional  
**Optics:** Type II  
**Lifetime (L70):** 100,000h  
**Available on request:** External driver

**ES**  
Luminaria de alumbrado público profesional con fuentes de luz LED.  
**Información General**  
**Voltaje:** DC 48V  
**LED:** PHILIPS LUMILEDS  
**Conductor:** N/A  
**Cuerpo:** Aluminio fundido a alta presión  
**Color:** Gris oscuro  
**Cubierta:** Policarbonato  
**Diámetro del poste:** 50mm  
**Ambiente de trabajo:** -40°C ~ +50°C; 10% ~ 90% deRH  
**Clase de protección:** Clase III, Clase I y II son opcionales  
**Óptica:** Tipo II  
**Vida útil (L70):** 100,000h  
**Disponible:** driver externo

**FR**  
Lampadaire professionnel avec sources lumineuses LED.  
**Données Générales**  
**Tension:** DC 48V  
**LED:** PHILIPS LUMILEDS  
**Alimentation:** N/A  
**Corps:** Aluminium moulé sous pression  
**Couleur:** Gris foncé  
**Couverture:** Polycarbonate  
**Diamètre du Mât:** 50mm  
**Environnement de Travail:** -40 °C ~ +50 °C; 10% ~ 90%RH  
**Classe de Protection:** Classe III, Classe I et Classe II sont optionnelles  
**Optique:** Type II  
**Durée de Vie (L70):** 100,000h  
**Disponible sur demande:** Alimentation externe

CE RoHS LM-80 TM-21 IP66 IK10

# LED STREET LIGHT



## Regular Version | Versión regular | Version Régulière

ZGSM-LD20N	20	2920	146	3000 /4000 /5000 /5700	>70	>0.95	290*180*100	1.53
ZGSM-LD20N+	20	3120	156	3000 /4000 /5000 /5700	>70	>0.95	290*180*100	1.53
ZGSM-LD30N	30	4200	140	3000 /4000 /5000 /5700	>70	>0.95	290*180*100	1.53
ZGSM-LD30N+	30	4530	151	3000 /4000 /5000 /5700	>70	>0.95	290*180*100	1.53
ZGSM-LD40N	40	5600	140	3000 /4000 /5000 /5700	>70	>0.95	290*180*100	1.53
ZGSM-LD40N+	40	5880	147	3000 /4000 /5000 /5700	>70	>0.95	290*180*100	1.53
ZGSM-LD50N	50	7100	142	3000 /4000 /5000 /5700	>70	>0.95	290*180*100	1.53

## High Efficiency | Alta eficiencia | Haute Efficacité

ZGSM-LD20N	20	3080	154	3000 /4000 /5000 /5700	>70	>0.95	290*180*100	1.53
ZGSM-LD20N+	20	3200	160	3000 /4000 /5000 /5700	>70	>0.95	290*180*100	1.53
ZGSM-LD30N	30	4500	150	3000 /4000 /5000 /5700	>70	>0.95	290*180*100	1.53
ZGSM-LD40N	40	6000	150	3000 /4000 /5000 /5700	>70	>0.95	290*180*100	1.53
ZGSM-LD50N	50	7500	150	3000 /4000 /5000 /5700	>70	>0.95	290*180*100	1.53

Luminous flux tolerance +/- 5%. | Tolerancia de flujo luminoso +/- 5% | Tolérance du flux lumineux +/- 5%

## Optic | Óptica | Optique

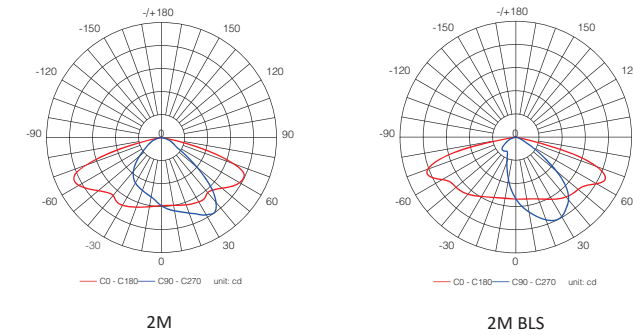

## Applications | Aplicaciones | Applications

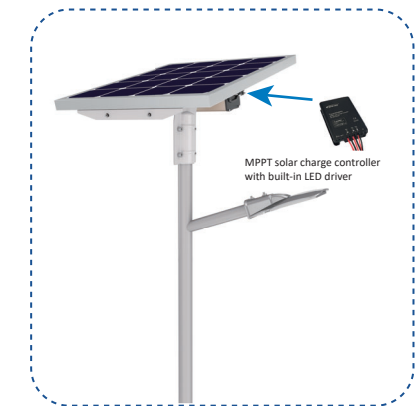

## Off-grid | Fuera de la red | Hors réseau



## Grid | Red | Réseau

## Adapters | Adaptadores | Adaptateurs

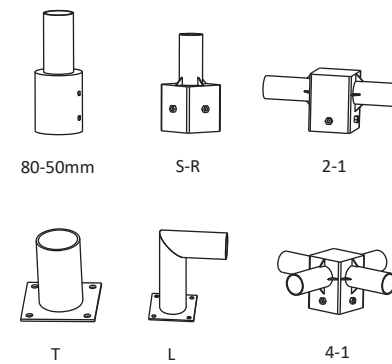





Adjustable tilt angle:  $\pm 0-5-10-15^\circ$   
 Ángulo de inclinación ajustable:  $\pm 0-5-10-15^\circ$   
 Angle d'inclinaison réglable :  $\pm 0-5-10-15^\circ$

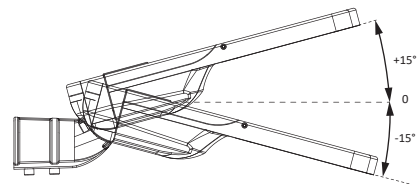

Horizontal /Horizontal /Horizontal

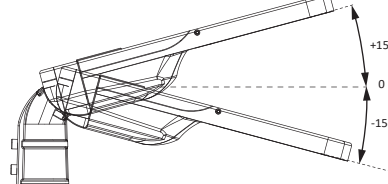

Vertical /Vertical /Vertical

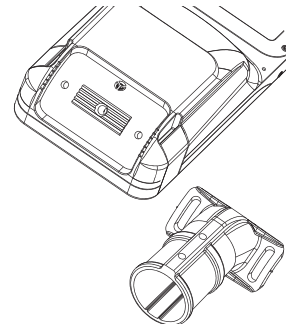

Fitter /Ajustador /Manche

**EN**  
 Professional streetlight luminaire with LED light sources.  
**General Data**  
**Voltage:** 100-240 /277V 50 /60Hz  
**LED:** PHILIPS LUMILEDS  
**Driver:** INVENTRONICS  
**Body:** High pressure die-cast aluminum  
**Colour:** Gray  
**Cover:** Toughened glass and Polycarbonate  
**Pole Diameter:** 60 mm  
**Working Environment:** -40°C ~ +50°C; 10% ~ 90%RH  
**Protection Class:** Class I, Class II is optional  
**Optics:** Type II, Type III  
**Lifetime (L70):** 100,000h  
**Available on request:** DALI, DIM 1-10V, OLC, Photocell, Knife switch, NTC

**ES**  
 Luminaria de alumbrado público profesional con fuentes de luz LED.  
**Información General**  
**Voltaje:** 100-240 /277V 50 /60Hz  
**LED:** PHILIPS LUMILEDS  
**Conductor:** INVENTRONICS  
**Cuerpo:** Aluminio fundido a alta presión  
**Color:** Gris  
**Cubierta:** Vidrio templado y policarbonato  
**Diámetro del poste:** 60mm  
**Ambiente de trabajo:** -40°C ~ +50°C; 10% ~ 90%RH  
**Clase de protección:** Clase I, Clase II es opcional  
**Óptica:** Tipo II, Tipo III  
**Vida útil (L70):** 100,000h  
**Disponible:** DALI, DIM 1-10V, OLC, Fotocélula, Interruptor de cuchilla, NTC

**FR**  
 Lampadaire professionnel avec sources lumineuses LED.  
**Données Générales**  
**Tension:** 100-240 /277V 50 /60Hz  
**LED:** PHILIPS LUMILEDS  
**Alimentation:** INVENTRONICS  
**Corps:** Aluminium moulé sous pression  
**Couleur:** Gris  
**Couverture:** Verre trempé et polycarbonate  
**Diamètre du Mât:** 60mm  
**Environnement de Travail:** -40°C ~ +50°C; 10% ~ 90%RH  
**Classe de Protection:** Classe I, Classe II est optionnelle  
**Optique:** Type II, Type III  
**Durée de Vie (L70):** 100,000h  
**Disponible sur demande:** DALI, DIM 1-10V, OLC, Photocellule, Disjoncteur, NTC

CE CB ENEC RoHS IP66 IK10 LM-79 LM-80 TM-21 LM-82

## LED STREET LIGHT



### Regular Version | Versión regular | Version Régulière

Model	Height (m)	Beam Diameter (m)	Beam Angle (°)	Light Output (lm)	Power (W)	Efficiency (lm/W)	Beam Diameter (m)	Weight (kgs)
ZGSM-ST17-20S	20	3100	155	3000 /4000 /5000 /5700	>70	>0.95	545*240*175	5.0
ZGSM-ST17-20S+	20	3300	165	3000 /4000 /5000 /5700	>70	>0.95	545*240*175	5.0
ZGSM-ST17-40S	40	6000	150	3000 /4000 /5000 /5700	>70	>0.95	545*240*175	5.1
ZGSM-ST17-40S+	40	6400	160	3000 /4000 /5000 /5700	>70	>0.95	545*240*175	5.1
ZGSM-ST17-60S	60	9000	150	3000 /4000 /5000 /5700	>70	>0.95	545*240*175	5.2
ZGSM-ST17-80S	80	11200	140	3000 /4000 /5000 /5700	>70	>0.95	545*240*175	5.2
ZGSM-ST17-80M	80	12000	150	3000 /4000 /5000 /5700	>70	>0.95	600*295*175	6.3
ZGSM-ST17-80M+	80	12800	160	3000 /4000 /5000 /5700	>70	>0.95	600*295*175	6.3
ZGSM-ST17-100M	100	15500	155	3000 /4000 /5000 /5700	>70	>0.95	600*295*175	6.3
ZGSM-ST17-120M	120	18600	155	3000 /4000 /5000 /5700	>70	>0.95	600*295*175	6.4
ZGSM-ST17-150M	150	21750	145	3000 /4000 /5000 /5700	>70	>0.95	600*295*175	6.4
ZGSM-ST17-150L	150	22500	150	3000 /4000 /5000 /5700	>70	>0.95	705*345*175	8.6
ZGSM-ST17-150L+	150	24000	160	3000 /4000 /5000 /5700	>70	>0.95	705*345*175	8.6
ZGSM-ST17-180L	180	27000	150	3000 /4000 /5000 /5700	>70	>0.95	705*345*175	8.7
ZGSM-ST17-200L	200	30000	150	3000 /4000 /5000 /5700	>70	>0.95	705*345*175	8.8
ZGSM-ST17-240L	240	36000	150	3000 /4000 /5000 /5700	>70	>0.95	705*345*175	8.8

### High Efficiency | Alta eficiencia | Haute Efficacité

Model	Height (m)	Beam Diameter (m)	Beam Angle (°)	Light Output (lm)	Power (W)	Efficiency (lm/W)	Beam Diameter (m)	Weight (kgs)
ZGSM-ST17-20S	20	3200	160	3000 /4000 /5000 /5700	>70	>0.95	545*240*175	5.0
ZGSM-ST17-20S+	20	3400	170	3000 /4000 /5000 /5700	>70	>0.95	545*240*175	5.0
ZGSM-ST17-40S	40	6400	160	3000 /4000 /5000 /5700	>70	>0.95	545*240*175	5.1
ZGSM-ST17-40S+	40	6600	165	3000 /4000 /5000 /5700	>70	>0.95	545*240*175	5.1
ZGSM-ST17-60S	60	9600	160	3000 /4000 /5000 /5700	>70	>0.95	545*240*175	5.2
ZGSM-ST17-80S	80	12400	155	3000 /4000 /5000 /5700	>70	>0.95	545*240*175	5.2
ZGSM-ST17-80M	80	12800	160	3000 /4000 /5000 /5700	>70	>0.95	600*295*175	6.3
ZGSM-ST17-80M+	80	13600	170	3000 /4000 /5000 /5700	>70	>0.95	600*295*175	6.3
ZGSM-ST17-100M	100	16500	165	3000 /4000 /5000 /5700	>70	>0.95	600*295*175	6.3
ZGSM-ST17-120M	120	19200	160	3000 /4000 /5000 /5700	>70	>0.95	600*295*175	6.4
ZGSM-ST17-150M	150	23250	155	3000 /4000 /5000 /5700	>70	>0.95	600*295*175	6.4
ZGSM-ST17-150L	150	23250	155	3000 /4000 /5000 /5700	>70	>0.95	705*345*175	8.6
ZGSM-ST17-150L+	150	24750	165	3000 /4000 /5000 /5700	>70	>0.95	705*345*175	8.6
ZGSM-ST17-180L	180	28800	160	3000 /4000 /5000 /5700	>70	>0.95	705*345*175	8.7
ZGSM-ST17-200L	200	32000	160	3000 /4000 /5000 /5700	>70	>0.95	705*345*175	8.8
ZGSM-ST17-240L	240	38400	160	3000 /4000 /5000 /5700	>70	>0.95	705*345*175	8.8

Luminous flux tolerance +/- 5%. | Tolerancia de flujo luminoso +/- 5% | Tolérance du flux lumineux +/- 5%

### Optic | Óptica | Optique

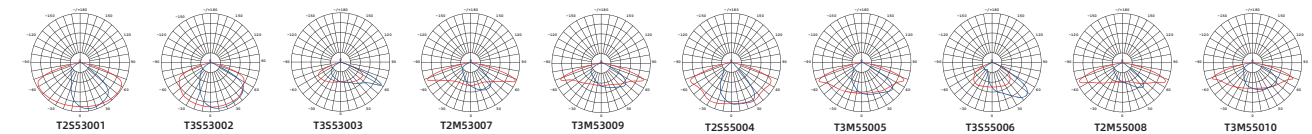

### Accessories | Accesorios | Accessoires

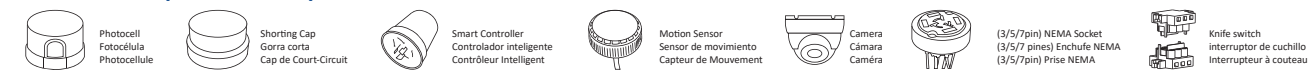

### Adapters | Adaptadores | Adaptateurs

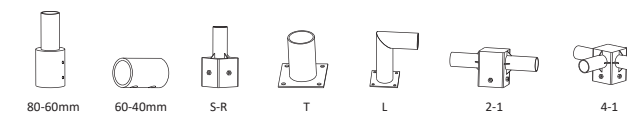

# Nova

**NEW**

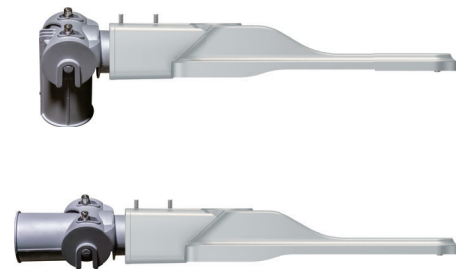
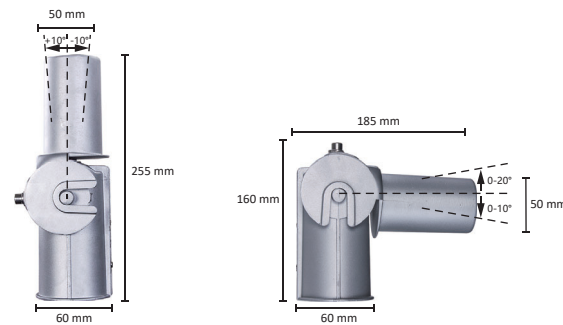
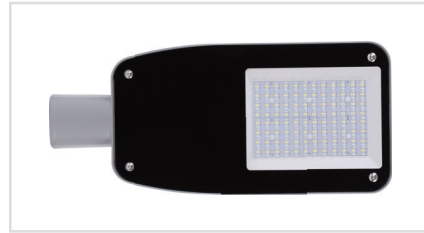

**EN**  
Professional streetlight luminaire with LED light sources.  
**General Data**  
**Voltage:** 100-240 /277V 50 /60Hz  
**LED:** BRIDGELUX  
**Driver:** DONE  
**Body:** High pressure die-cast aluminum  
**Colour:** Gray  
**Cover:** Toughened glass  
**Pole Diameter:** 60mm  
**Working Environment:** -40°C ~ +50°C; 10% ~90%RH  
**Protection Class:** Class I, Class II is optional  
**Optics:** Type II, Type III  
**Lifetime (L70):** 100, 000h  
**Available on request:** DALI, DIM 1-10V, OLC, Photocell, NTC, ZHAGA socket

**ES**  
Luminaria de alumbrado público profesional con fuentes de luz LED.  
**Información General**  
**Voltaje:** 100-240 /277V 50 /60Hz  
**LED:** BRIDGELUX  
**Conductor:** DONE  
**Cuerpo:** Aluminio fundido a alta presión  
**Color:** Gris  
**Cubierta:** Vidrio templado  
**Diámetro del poste:** 60mm  
**Ambiente de trabajo:** -40°C ~ +50°C; 10% ~ 90%RH  
**Clase de protección:** Clase I, Clase II es opcional  
**Óptica:** Tipo II, Tipo III  
**Vida útil (L70):** 100, 000h  
**Disponible:** DALI, DIM 1-10V, OLC, Fococélula, NTC, enchufe ZHAGA

**FR**  
Lampadaire professionnel avec sources lumineuses LED.  
**Données Générales**  
**Tension:** 100-240 /277V 50 /60Hz  
**LED:** BRIDGELUX  
**Alimentation:** DONE  
**Corps:** Aluminium moulé sous pression  
**Couleur:** Gris  
**Couverture:** Verre trempé  
**Diamètre du Mât:** 60mm  
**Environnement de Travail:** -40°C ~ +50°C; 10% ~ 90%RH  
**Classe de Protection:** Classe I, Classe II est optionnelle  
**Optique:** Type II, Type III  
**Durée de Vie (L70):** 100, 000h  
**Disponible sur demande:** DALI, DIM 1-10V, OLC, Photocellule, NTC, Prise ZHAGA

CE / RoHS | IP66 / IK10 | LM-79 / LM-80 | TM-21

## LED STREET LIGHT



### Regular Version | Versión regular | Version Régulière

Model	Height (mm)	Power (W)	Beam Angle (°)	Light Output (lm)	Beam Spread (m)	Beam Spread (m)	Beam Spread (m)	Weight (kgs)
ZGSM-ST18-30S	30	3900	130	3000 /4000 /5000 /5700	>70	>0.90	425*165*135	2.3
ZGSM-ST18-40S	40	5200	130	3000 /4000 /5000 /5700	>70	>0.90	425*165*135	2.3
ZGSM-ST18-50S	50	6500	130	3000 /4000 /5000 /5700	>70	>0.90	425*165*135	2.3
ZGSM-ST18-60M	60	7800	130	3000 /4000 /5000 /5700	>70	>0.90	455*205*135	2.9
ZGSM-ST18-80M	80	10400	130	3000 /4000 /5000 /5700	>70	>0.90	455*205*135	2.9
ZGSM-ST18-100M	100	12000	120	3000 /4000 /5000 /5700	>70	>0.90	455*205*135	2.9
ZGSM-ST18-120L	120	15600	130	3000 /4000 /5000 /5700	>70	>0.90	535*255*135	4.3
ZGSM-ST18-150L	150	19500	130	3000 /4000 /5000 /5700	>70	>0.90	535*255*135	4.3

### High Efficiency | Alta eficiencia | Haute Efficacité

Model	Height (mm)	Power (W)	Beam Angle (°)	Light Output (lm)	Beam Spread (m)	Beam Spread (m)	Beam Spread (m)	Weight (kgs)
ZGSM-ST18-30S	30	4200	140	3000 /4000 /5000 /5700	>70	>0.90	425*165*135	2.3
ZGSM-ST18-40S	40	5600	140	3000 /4000 /5000 /5700	>70	>0.90	425*165*135	2.3
ZGSM-ST18-50S	50	7000	140	3000 /4000 /5000 /5700	>70	>0.90	425*165*135	2.3
ZGSM-ST18-60M	60	8400	140	3000 /4000 /5000 /5700	>70	>0.90	455*205*135	2.9
ZGSM-ST18-80M	80	11200	140	3000 /4000 /5000 /5700	>70	>0.90	455*205*135	2.9
ZGSM-ST18-100M	100	13000	130	3000 /4000 /5000 /5700	>70	>0.90	455*205*135	2.9
ZGSM-ST18-120L	120	16800	140	3000 /4000 /5000 /5700	>70	>0.90	535*255*135	4.3
ZGSM-ST18-150L	150	21000	140	3000 /4000 /5000 /5700	>70	>0.90	535*255*135	4.3

Luminous flux tolerance +/- 5%. | Tolerancia de flujo luminoso +/- 5% | Tolérance du flux lumineux +/- 5%

### Optic | Óptica | Optique

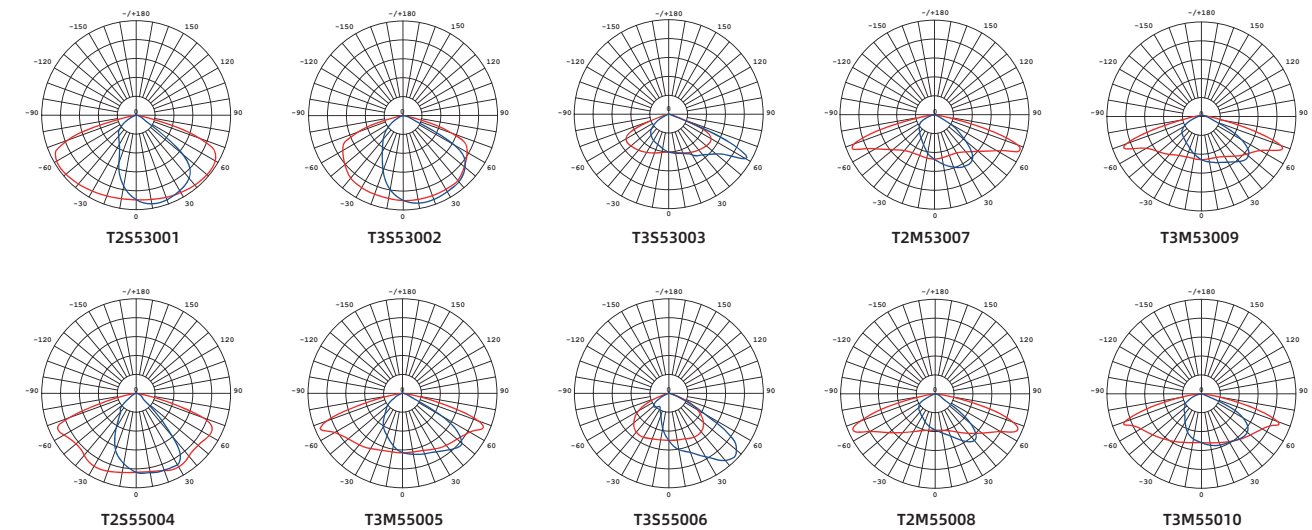

### Accessories | Accesorios | Accessoires

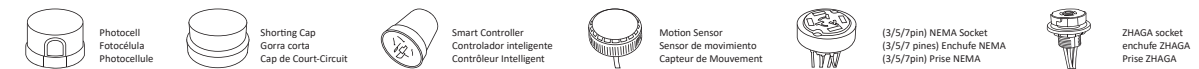

### Adapters | Adaptadores | Adaptateurs

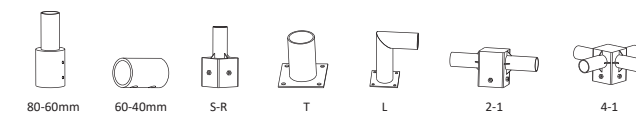





## LED HIGH BAY LIGHT LED FOCO INDUSTRIAL LUMINAIRE INDUSTRIEL LED

### EN

LED high bay series provide remarkable lighting solution mainly for warehouse, factory, gymnasium or any large and cavernous space. ZGSM lighting is innovative not only in outlook design but also offers durable and costeffective performance.

The light efficiency reaches from 130lm/w to 190lm/w. They are compatible with intelligent control system which ensures longer lifespan and lowers 90% cost. Moreover, ZGSM high bay family have multiple professional optical lens and various installation accessories which meet all your requirements for any projects.

### ES

La serie LED foco industrial proporciona una solución de iluminación notable principalmente para almacenes, fábricas, gimnasios o cualquier espacio grande y cavernoso. Iluminación ZGSM que no solo es innovadora en términos de diseño de perspectiva, sino que también ofrece un rendimiento duradero y rentable. Estas luces alcanzan la eficiencia de 130lm/w a 190lm/w disponibles. Y son compatibles con el sistema de control inteligente que garantiza una vida útil más larga y reduce el costo del 90%. Además, la familia ZGSM foco industrial diseñó múltiples lentes ópticas profesionales y varios accesorios de instalación que cumplen con todos sus requisitos para cualquier proyecto.

### FR

Les séries de luminaire industriel LED fournissent une solution d'éclairage remarquable principalement pour les entrepôts, les usines, les stades ou tout espace vaste et caverneux. L'éclairage ZGSM est non seulement innovant dans la conception d'apparence, mais offre également des performances durables et rentables. L'efficacité de ces lumières atteint de 130lm/w à 190lm/w. Et ils sont compatibles avec le système de contrôle intelligent qui assure une durée de vie plus longue et réduit les coûts de 90%. De plus, la famille des luminaires industriels ZGSM a conçu plusieurs lentilles optiques professionnelles et divers accessoires de montage pour répondre à toutes vos exigences pour tout projet.





### Installation | Instalación | Installation

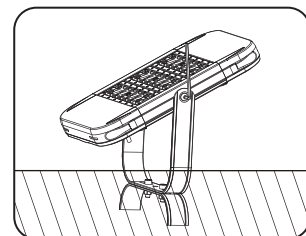
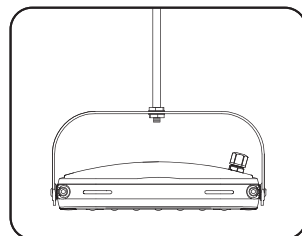
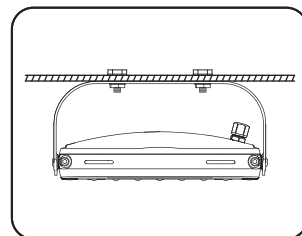
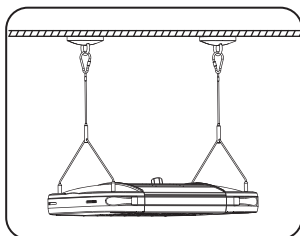

#### EN

Industrial luminaire designed to light up large-area objects.

##### General Data

**Voltage:** 100-240 /277V 50 /60Hz

**LED:** PHILIPS LUMILEDS

**Driver:** MEANWELL /INVENTRONICS

**Body:** High pressure die-cast aluminum

**Colour:** Silver

**Cover:** Polycarbonate

**Mounting:** Various brackets or wire rope

**Working Environment:** -40°C ~ +50°C; 10% ~ 90%RH

**Protection Class:** Class I, Class II is optional

**Optics:** 60, 90 or 110 degrees

**Lifetime (L70):** 100, 000h

**Available on request:** DALI, DIM 1-10V, OLC, NTC, TIMER DIM

#### ES

Luminaria industrial diseñada para iluminar objetos de gran superficie.

##### Información General

**Voltaje:** 100-240 /277V 50 /60Hz

**LED:** PHILIPS LUMILEDS

**Conductor:** MEANWELL /INVENTRONICS

**Cuerpo:** Aluminio fundido a alta presión

**Color:** Plateado

**Cubierta:** Policarbonato

**Montaje:** Varios soportes o cable de acero

**Ambiente de trabajo:** -40°C ~ +50°C; 10% ~ 90%RH

**Clase de protección:** Clase I, Clase II es opcional

**Óptica:** 60, 90 o 110 grados

**Vida útil (L70):** 100, 000h

**Disponible:** DALI, DIM 1-10V, OLC, NTC, TIMER DIM

#### FR

Luminaire industriel conçu pour éclairer des objets de grande surface.

##### Données Générales

**Tension:** 100-240 /277V 50 /60Hz

**LED:** PHILIPS LUMILEDS

**Alimentation:** MEANWELL /INVENTRONICS

**Corps:** Aluminium moulé sous pression

**Couleur:** Argenté

**Couverture:** Polycarbonate

**Montage:** Divers supports ou câble métallique

**Environnement de Travail:** -40°C ~ +50°C; 10% ~ 90%RH

**Classe de Protection:** Classe I, Classe II est optionnelle

**Optique:** 60, 90 ou 110 degrés

**Durée de Vie (L70):** 100, 000 h

**Disponible sur demande:** DALI, DIM 1-10V, OLC, NTC, TIMER DIM

CE  
RoHS

CB  
SAA

UL  
DLC

LM-79  
LM-80

IP66  
IK10

## LED HIGH BAY LIGHT



### Regular Version | Versión regular | Version Régulière

Model	W	lm	lm/W	CCT	Ra/CRI	COSφ PF	mm	kg
ZGSM-GCD40H4	40	5600	140	3000 /4000 /5000 /5700	>70	>0.95	345*365*160	3.9
ZGSM-GCD50H5	50	6500	130	3000 /4000 /5000 /5700	>70	>0.95	345*365*160	3.9
ZGSM-GCD60H6	60	7500	125	3000 /4000 /5000 /5700	>70	>0.95	345*365*160	3.9
ZGSM-GCD80H4	80	11200	140	3000 /4000 /5000 /5700	>70	>0.95	415*365*160	5.2
ZGSM-GCD100H5	100	13000	130	3000 /4000 /5000 /5700	>70	>0.95	415*365*160	5.2
ZGSM-GCD120H6	120	15000	125	3000 /4000 /5000 /5700	>70	>0.95	415*365*160	5.2
ZGSM-GCD120H4	120	16800	140	3000 /4000 /5000 /5700	>70	>0.95	485*365*160	6.3
ZGSM-GCD150H5	150	19500	130	3000 /4000 /5000 /5700	>70	>0.95	485*365*160	6.3
ZGSM-GCD180H6	180	22500	125	3000 /4000 /5000 /5700	>70	>0.95	485*365*160	6.3
ZGSM-GCD160H4	160	22400	140	3000 /4000 /5000 /5700	>70	>0.95	560*365*160	7.3
ZGSM-GCD200H5	200	26000	130	3000 /4000 /5000 /5700	>70	>0.95	560*365*160	7.3
ZGSM-GCD240H6	240	30000	125	3000 /4000 /5000 /5700	>70	>0.95	560*365*160	7.3
ZGSM-GCD200H4	200	28000	140	3000 /4000 /5000 /5700	>70	>0.95	635*365*160	8.3
ZGSM-GCD240H5	240	31200	130	3000 /4000 /5000 /5700	>70	>0.95	635*365*160	8.3
ZGSM-GCD300H6	300	37500	125	3000 /4000 /5000 /5700	>70	>0.95	635*365*160	8.3

### High Efficiency | Alta eficiencia | Haute Efficacité

Model	W	lm	lm/W	CCT	Ra/CRI	COSφ PF	mm	kg
ZGSM-GCD40H4	40	6600	165	3000 /4000 /5000 /5700	>70	>0.95	345*365*160	3.9
ZGSM-GCD50H5	50	8000	160	3000 /4000 /5000 /5700	>70	>0.95	345*365*160	3.9
ZGSM-GCD60H6	60	9300	155	3000 /4000 /5000 /5700	>70	>0.95	345*365*160	3.9
ZGSM-GCD80H4	80	13200	165	3000 /4000 /5000 /5700	>70	>0.95	415*365*160	5.2
ZGSM-GCD100H5	100	16000	160	3000 /4000 /5000 /5700	>70	>0.95	415*365*160	5.2
ZGSM-GCD120H6	120	18600	155	3000 /4000 /5000 /5700	>70	>0.95	415*365*160	5.2
ZGSM-GCD120H4	120	19800	165	3000 /4000 /5000 /5700	>70	>0.95	485*365*160	6.3
ZGSM-GCD150H5	150	24000	160	3000 /4000 /5000 /5700	>70	>0.95	485*365*160	6.3
ZGSM-GCD180H6	180	27900	155	3000 /4000 /5000 /5700	>70	>0.95	485*365*160	6.3
ZGSM-GCD160H4	160	26400	165	3000 /4000 /5000 /5700	>70	>0.95	560*365*160	7.3
ZGSM-GCD200H5	200	32000	160	3000 /4000 /5000 /5700	>70	>0.95	560*365*160	7.3
ZGSM-GCD240H6	240	37200	155	3000 /4000 /5000 /5700	>70	>0.95	560*365*160	7.3
ZGSM-GCD200H4	200	33000	165	3000 /4000 /5000 /5700	>70	>0.95	635*365*160	8.3
ZGSM-GCD240H5	240	38400	160	3000 /4000 /5000 /5700	>70	>0.95	635*365*160	8.3
ZGSM-GCD300H6	300	46500	155	3000 /4000 /5000 /5700	>70	>0.95	635*365*160	8.3

Luminous flux tolerance +/- 5%. | Tolerancia de flujo luminoso +/- 5% | Tolérance du flux lumineux +/- 5%

### Optic | Óptica | Optique

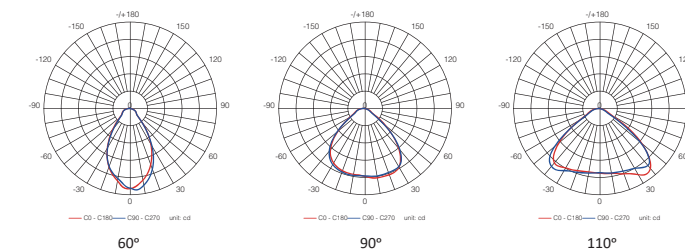

### Accessories | Accesorios | Accessoires



Motion Sensor  
Sensor de movimiento  
Capteur de Mouvement

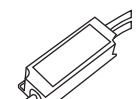

Zigbee Controller  
Controlador Zigbee  
Contrôleur Zigbee



Wire rope  
Cuerda de alambre  
Câble





CE  
RoHS

IP65  
IK10

LM-80  
TM-21

# LED HIGH BAY LIGHT



## Regular Version | Versión regular | Version Régulière

Model	Power (W)	Beam Angle (°)	Height (mm)	Light Output (lm)	Efficiency (lm/W)	CCT (K)	Power Factor (PF)	Dimensions (mm)	Weight (kgs)
ZGSM-UFO100M	100	14000	140	3000 / 4000 / 5000 / 5700	>70	>0.95	365*365*210	5.2	
ZGSM-UFO160M	160	22400	140	3000 / 4000 / 5000 / 5700	>70	>0.95	365*365*210	6.0	
ZGSM-UFO200M	200	28000	140	3000 / 4000 / 5000 / 5700	>70	>0.95	365*365*210	6.0	

## High Efficiency | Alta eficiencia | Haute Efficacité

Model	Power (W)	Beam Angle (°)	Height (mm)	Light Output (lm)	Efficiency (lm/W)	CCT (K)	Power Factor (PF)	Dimensions (mm)	Weight (kgs)
ZGSM-UFO100M	100	15500	155	3000 / 4000 / 5000 / 5700	>70	>0.95	365*365*210	5.2	
ZGSM-UFO160M	160	24800	155	3000 / 4000 / 5000 / 5700	>70	>0.95	365*365*210	6.0	
ZGSM-UFO200M	200	31000	155	3000 / 4000 / 5000 / 5700	>70	>0.95	365*365*210	6.0	

Luminous flux tolerance +/- 5% | Tolerancia de flujo luminoso +/- 5% | Tolérance de flux lumineux +/- 5%

## Installation | Instalación | Installation

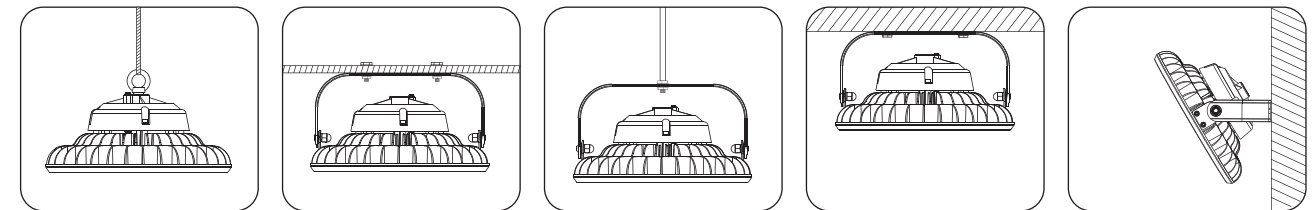

## Optic | Óptica | Optique

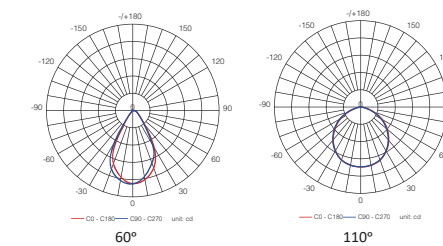

## Accessories | Accesorios | Accessoires

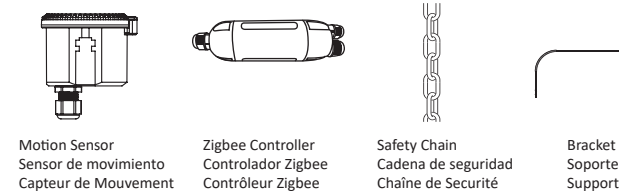

### EN

Industrial luminaire designed to light up large-area objects.

#### General Data

**Voltage:** 100-240 / 277V 50 / 60Hz

**LED:** PHILIPS LUMILEDS

**Driver:** MEANWELL

**Body:** High pressure die-cast aluminum

**Colour:** Black

**Cover:** Polycarbonate or Toughened glass

**Mounting:** Hook Loop or Various brackets

**Working Environment:** -40°C ~ +50°C; 10% ~ 90%RH

**Protection Class:** Class I

**Optics:** 60 or 110 degrees

**Lifetime (L70):** 100, 000h

**Available on request:** DALI, DIM 1-10V, OLC, NTC, TIMER DIM

### ES

Luminaria industrial diseñada para iluminar objetos de gran superficie.

#### Información General

**Voltaje:** 100-240 / 277V 50 / 60Hz

**LED:** PHILIPS LUMILEDS

**Conductor:** MEANWELL

**Cuerpo:** Aluminio fundido a alta presión

**Color:** Negro

**Cubierta:** Policarbonato o vidrio templado

**Montaje:** Bucle de gancho o varios soportes

**Ambiente de trabajo:** -40°C ~ +50°C; 10% ~ 90%RH

**Clase de protección:** Clase I

**Óptica:** 60 o 110 grados

**Vida útil (L70):** 100, 000h

**Disponible:** DALI, DIM 1-10V, OLC, NTC, TIMER DIM

### FR

Luminaire industriel conçu pour éclairer des objets de grande surface.

#### Données Générales

**Tension:** 100-240 / 277V 50 / 60Hz

**LED:** PHILIPS LUMILEDS

**Alimentation:** MEANWELL

**Corps:** Aluminium moulé sous pression

**Couleur:** Noir

**Couverture:** Polycarbonate ou Verre Trempé

**Montage:** Boucle de Crochet ou Divers supports

**Environnement de Travail:** -40°C ~ +50°C; 10% ~ 90%RH

**Classe de Protection:** Classe I

**Optique:** 60 ou 110 degrés

**Durée de Vie (L70):** 100, 000h

**Disponible sur demande:** DALI, DIM 1-10V, OLC, NTC, TIMER DIM

# Helios

**NEW**



CE / RoHS | IP65 / IK10 | LM-80 / TM-21

## LED HIGH BAY LIGHT



### Regular Version | Versión regular | Version Régulière

Model	Power (W)	Flux (lm)	Efficiency (lm/W)	Beam Spread	Power Factor (PF)	Dimensions (mm)	Weight (kgs)
ZGSM-HB09-100S	100	14500	145	3000 / 4000 / 5000 / 5700	>70	330*330*155	3.2
ZGSM-HB09-150S	150	21000	140	3000 / 4000 / 5000 / 5700	>70	330*330*155	3.2
ZGSM-HB09-200M	200	29000	145	3000 / 4000 / 5000 / 5700	>70	375*375*155	4.2

### High Efficiency | Alta eficiencia | Haute Efficacité

Model	Power (W)	Flux (lm)	Efficiency (lm/W)	Beam Spread	Power Factor (PF)	Dimensions (mm)	Weight (kgs)
ZGSM-HB09-100S	100	19000	190	3000 / 4000 / 5000 / 5700	>70	330*330*155	3.2
ZGSM-HB09-150M	150	28500	190	3000 / 4000 / 5000 / 5700	>70	375*375*155	4.2
ZGSM-HB09-200M	200	38000	190	3000 / 4000 / 5000 / 5700	>70	375*375*155	4.2

Luminous flux tolerance +/- 5% | Tolerancia de flujo luminoso +/- 5% | Tolérance du flux lumineux +/- 5%

### Installation | Instalación | Installation

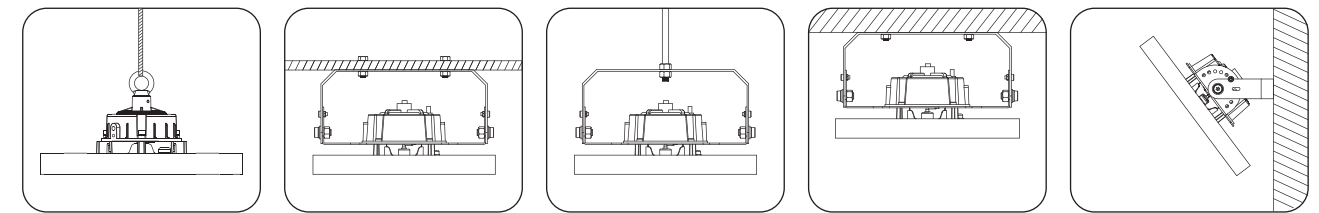

### Optic | Óptica | Optique

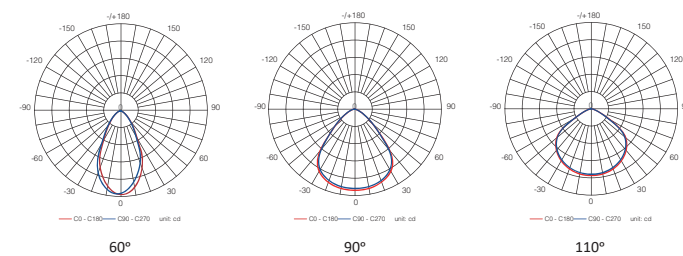

#### EN

Industrial luminaire designed to light up large-area objects.

##### General Data

**Voltage:** 100-240 / 277V 50 / 60Hz

**LED:** PHILIPS LUMILEDS

**Driver:** MOSO / SOSEN

**Body:** High pressure die-cast aluminum

**Colour:** Black

**Cover:** Polycarbonate

**Mounting:** Hook Loop or Various brackets

**Working Environment:** -40°C ~ +50°C; 10% ~ 90%RH

**Protection Class:** Class I

**Optics:** 60, 90 or 110 degrees

**Lifetime (L70):** 50,000h

**Available on request:** DALI, DIM 1-10V, TIMER DIM

#### ES

Luminaria industrial diseñada para iluminar objetos de gran superficie.

##### Información General

**Voltaje:** 100-240 / 277V 50 / 60Hz

**LED:** PHILIPS LUMILEDS

**Conductor:** MOSO / SOSEN

**Cuerpo:** Aluminio fundido a alta presión

**Color:** Negro

**Cubierta:** Policarbonato

**Montaje:** Bucle de gancho o varios soportes

**Ambiente de trabajo:** -40°C ~ +50°C; 10% ~ 90%rh

**Clase de protección:** Clase I

**Óptica:** 60, 90 o 110 grados

**Vida útil (L70):** 50,000h

**Disponible:** DALI, DIM 1-10V, TIMER DIM

#### FR

Luminaire industriel conçu pour éclairer des objets de grande surface.

##### Données Générales

**Tension:** 100-240 / 277V 50 / 60Hz

**LED:** PHILIPS LUMILEDS

**Alimentation:** MOSO / SOSEN

**Corps:** Aluminium moulé sous pression

**Couleur:** Noir

**Couverture:** Polycarbonate

**Montage:** Boucle de Crochet ou Divers supports

**Environnement de Travail:** -40°C ~ +50°C; 10% ~ 90%rh

**Classe de Protection:** Classe I

**Optique:** 60, 90 ou 110 degrés

**Durée de Vie (L70):** 50,000h

**Disponible sur demande:** DALI, DIM 1-10V, TIMER DIM

### Accessories | Accesorios | Accessoires







## LED FLOOD LIGHT LED REFLECTOR PROJECTEUR LED

### EN

ZGSM LED flood light family are mainly designed for area lighting, sport lighting, parking lots and billboard lighting. Full power ranges and symmetric or asymmetric beam angles can satisfy the most application demands. They are ideal illuminating for any outdoor area as well as dramatically reducing energy consumption.

### ES

Familia de reflectores LED ZGSM diseñados principalmente para iluminación de áreas, iluminación deportiva, estacionamientos y vallas publicitarias. Rangos de potencia completos y ángulos de haz simétricos o asimétricos para satisfacer las necesidades de la mayoría de aplicaciones. son ideales para iluminar cualquier área al aire libre y reducen drásticamente el consumo de energía.

### FR

La famille des projecteurs LED ZGSM est principalement conçue pour l'éclairage de zone, l'éclairage sportif, l'éclairage des parkings et des panneaux d'affichage. La plage de puissance complète et les angles de faisceau symétriques ou asymétriques peuvent satisfaire la plupart des besoins d'application. Ils sont idéaux pour éclairer tout espace extérieur ainsi que réduire considérablement la consommation d'énergie.





# LED FLOOD LIGHT



## Regular Version | Versión regular | Version Régulière

Model	W	H	D	Beam Angle	Power	Efficiency	Dimensions	Weight
ZGSM-FGD40H4B	40	5600	140	3000 / 4000 / 5000 / 5700	>70	>0.95	285*370*200	3.1
ZGSM-FGD50H5B	50	6500	130	3000 / 4000 / 5000 / 5700	>70	>0.95	285*370*200	3.1
ZGSM-FGD60H6B	60	7500	125	3000 / 4000 / 5000 / 5700	>70	>0.95	285*370*200	3.1
ZGSM-FGD80H4B	80	11200	140	3000 / 4000 / 5000 / 5700	>70	>0.95	355*370*200	4.4
ZGSM-FGD100H5B	100	13000	130	3000 / 4000 / 5000 / 5700	>70	>0.95	355*370*200	4.4
ZGSM-FGD120H6B	120	15000	125	3000 / 4000 / 5000 / 5700	>70	>0.95	355*370*200	4.4
ZGSM-FGD120H4B	120	16800	140	3000 / 4000 / 5000 / 5700	>70	>0.95	430*370*200	5.4
ZGSM-FGD150H5B	150	19500	130	3000 / 4000 / 5000 / 5700	>70	>0.95	430*370*200	5.4
ZGSM-FGD180H6B	180	22500	125	3000 / 4000 / 5000 / 5700	>70	>0.95	430*370*200	5.4
ZGSM-FGD160H4B	160	22400	140	3000 / 4000 / 5000 / 5700	>70	>0.95	505*370*200	6.3
ZGSM-FGD200H5B	200	26000	130	3000 / 4000 / 5000 / 5700	>70	>0.95	505*370*200	6.3
ZGSM-FGD240H6B	240	30000	125	3000 / 4000 / 5000 / 5700	>70	>0.95	505*370*200	6.3
ZGSM-FGD200H4B	200	28000	140	3000 / 4000 / 5000 / 5700	>70	>0.95	580*370*200	7.2
ZGSM-FGD240H5B	240	31200	130	3000 / 4000 / 5000 / 5700	>70	>0.95	580*370*200	7.2
ZGSM-FGD300H6B	300	37500	125	3000 / 4000 / 5000 / 5700	>70	>0.95	580*370*200	7.2

## High Efficiency | Alta eficiencia | Haute Efficacité

Model	W	H	D	Beam Angle	Power	Efficiency	Dimensions	Weight
ZGSM-FGD40H4B	40	6600	165	3000 / 4000 / 5000 / 5700	>70	>0.95	285*370*200	3.1
ZGSM-FGD50H5B	50	8000	160	3000 / 4000 / 5000 / 5700	>70	>0.95	285*370*200	3.1
ZGSM-FGD60H6B	60	9300	155	3000 / 4000 / 5000 / 5700	>70	>0.95	285*370*200	3.1
ZGSM-FGD80H4B	80	13200	165	3000 / 4000 / 5000 / 5700	>70	>0.95	355*370*200	4.4
ZGSM-FGD100H5B	100	16000	160	3000 / 4000 / 5000 / 5700	>70	>0.95	355*370*200	4.4
ZGSM-FGD120H6B	120	18600	155	3000 / 4000 / 5000 / 5700	>70	>0.95	355*370*200	4.4
ZGSM-FGD120H4B	120	19800	165	3000 / 4000 / 5000 / 5700	>70	>0.95	430*370*200	5.4
ZGSM-FGD150H5B	150	24000	160	3000 / 4000 / 5000 / 5700	>70	>0.95	430*370*200	5.4
ZGSM-FGD180H6B	180	27900	155	3000 / 4000 / 5000 / 5700	>70	>0.95	430*370*200	5.4
ZGSM-FGD160H4B	160	26400	165	3000 / 4000 / 5000 / 5700	>70	>0.95	505*370*200	6.3
ZGSM-FGD200H5B	200	32000	160	3000 / 4000 / 5000 / 5700	>70	>0.95	505*370*200	6.3
ZGSM-FGD240H6B	240	37200	155	3000 / 4000 / 5000 / 5700	>70	>0.95	505*370*200	6.3
ZGSM-FGD200H4B	200	33000	165	3000 / 4000 / 5000 / 5700	>70	>0.95	580*370*200	7.2
ZGSM-FGD240H5B	240	38400	160	3000 / 4000 / 5000 / 5700	>70	>0.95	580*370*200	7.2
ZGSM-FGD300H6B	300	46500	155	3000 / 4000 / 5000 / 5700	>70	>0.95	580*370*200	7.2

Luminous flux tolerance +/- 5%. | Tolerancia de flujo luminoso +/- 5% | Tolérance du flux lumineux +/- 5%

## Installation | Instalación | Installation

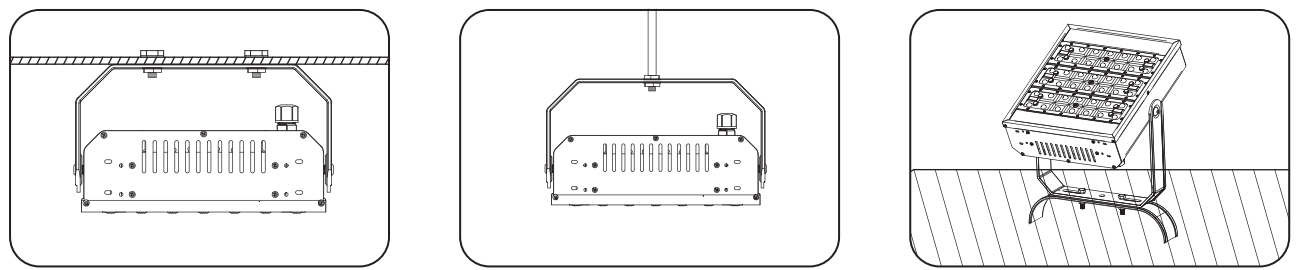

**EN**  
Modern floodlight with LED light source.  
**General Data**  
Voltage: 100-240 / 277V 50 / 60Hz  
LED: PHILIPS LUMILEDS  
Driver: MEANWELL / INVENTRONICS  
Body: Stretched aluminum  
Colour: Silver  
Cover: Polycarbonate  
Mounting: Various brackets  
Working Environment: -40°C ~ +50°C; 10% ~ 90%RH  
Protection Class: Class I, Class II is optional  
Optics: 60, 90 or 110 degrees  
Lifetime (L70): 100, 000h  
Available on request: DALI, DIM 1-10V, OLC, Photocell, TIMER DIM

**ES**  
Reflector moderno con fuente de luz LED.  
**Información General**  
Voltaje: 100-240 / 277V 50 / 60Hz  
LED: PHILIPS LUMILEDS  
Conductor: MEANWELL / INVENTRONICS  
Cuerpo: Aluminio estirado  
Color: Plateado  
Cubierta: Policarbonato  
Montaje: Varios soportes  
Ambiente de trabajo: -40°C ~ +50°C; 10% ~ 90%RH  
Clase de protección: Clase I, Clase II es opcional  
Óptica: 60, 90 o 110 grados  
Vida útil (L70): 100, 000h  
Disponible: DALI, DIM 1-10V, OLC, Fotocélula, TIMER DIM

**FR**  
Projecteur moderne avec sources lumineuses LED.  
**Données Générales**  
Tension: 100-240 / 277V 50 / 60Hz  
LED: PHILIPS LUMILEDS  
Alimentation: MEANWELL / INVENTRONICS  
Corps: Aluminium Étiré  
Couleur: Argenté  
Couverture: Polycarbonate  
Montage: Divers supports  
Environnement de Travail: -40°C ~ +50°C; 10% ~ 90% RH  
Classe de Protection: Classe I, Classe II est optionnelle  
Optique: 60, 90 ou 110 degrés  
Durée de Vie (L70): 100, 000h  
Disponible sur demande: DALI, DIM 1-10V, OLC, Photocellule, TIMER DIM

## Optic | Óptica | Optique

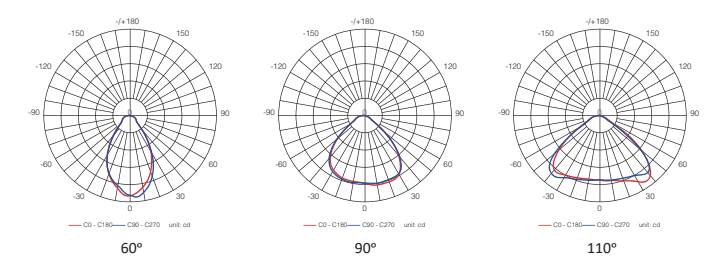

## Accessories | Accesorios | Accessoires

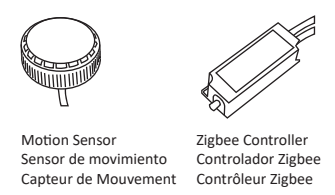

Motion Sensor  
Sensor de movimiento  
Capteur de Mouvement

Zigbee Controller  
Controlador Zigbee  
Contrôleur Zigbee



CE  
RoHS

TM-21  
LM-80

IP66  
IK08

## LED FLOOD LIGHT



### Regular Version | Versión regular | Version Régulière

Model	Power (W)	Beam Diameter (mm)	Height (mm)	Light Output (lm)	Beam Spread (°)	COSΦ PF	Dimensions (mm)	Weight (kgs)
ZGSM-FL08-10	10	1200	120	4000 / 5000	80	>0.95	335*250*210	8.6 (36units /ctn)
ZGSM-FL08-20	20	2400	120	4000 / 5000	80	>0.95	360*190*315	10.6 (30units /ctn)
ZGSM-FL08-30	30	3450	115	4000 / 5000	80	>0.95	350*205*300	11.8 (20units /ctn)
ZGSM-FL08-50	50	5750	115	4000 / 5000	80	>0.95	370*245*235	11.1 (12units /ctn)

Luminous flux tolerance +/- 5%. | Tolerancia de flujo luminoso +/- 5% | Tolérance du flux lumineux +/- 5%

### Installation | Instalación | Installation

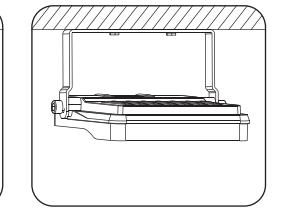
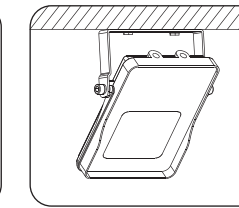
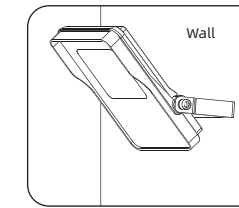
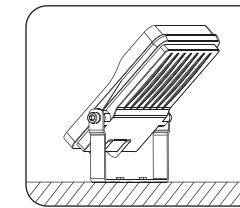
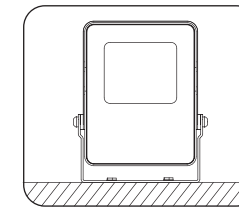

### Optic | Óptica | Optique

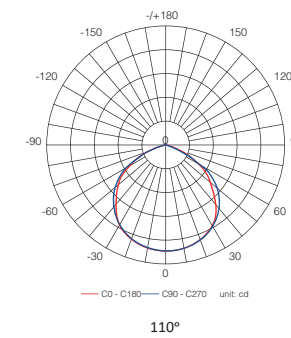

### Accessories | Accesorios | Accessoires



PIR Sensor  
Sensor PIR  
Capteur PIR

#### EN

Modern floodlight with LED light source.

##### General Data

**Voltage:** 220-240V 50 /60Hz  
**LED:** SMD2835  
**Driver:** Integrated LED driver  
**Body:** High pressure die-cast aluminum  
**Colour:** Black  
**Cover:** Toughened glass  
**Mounting:** Various brackets  
**Working Environment:** -40°C ~ +50°C; 10% ~ 90%RH  
**Protection Class:** Class I  
**Optics:** 110 degrees  
**Lifetime (L70):** 50,000h  
**Available on request:** RGB, RGBW, PIR SENSOR

#### ES

Reflector moderno con fuente de luz LED.

##### Información General

**Voltaje:** 220-240V 50 /60Hz  
**LED:** SMD2835  
**Controlador:** controlador LED integrado  
**Cuerpo:** Aluminio fundido a alta presión  
**Color:** Negro  
**Cubierta:** Vidrio templado  
**Montaje:** Varios soportes  
**Ambiente de trabajo:** -40°C ~ +50°C; 10% ~ 90%RH  
**Clase de protección:** Clase I  
**Óptica:** 110 grados  
**Vida útil (L70):** 50,000h  
**Disponible bajo pedido:** RGB, RGBW, PIR SENSOR

#### FR

Projecteur moderne avec sources lumineuses LED.

##### Données Générales

**Tension:** 220-240V 50 /60Hz  
**LED:** SMD2835  
**Alimentation:** Driver LED intégré  
**Corps:** Aluminium moulé sous pression  
**Couleur:** Noir  
**Couverture:** Verre Trempé  
**Montage:** Divers supports  
**Environnement de Travail:** -40°C ~ +50°C; 10% ~ 90%RH  
**Classe de Protection:** Classe I  
**Optique:** 110 degrés  
**Durée de Vie (L70):** 50,000h  
**Disponible sur demande:** RGB, RGBW, CAPTEUR PIR



# Zoom

**NEW**



## Installation | Instalación | Installation

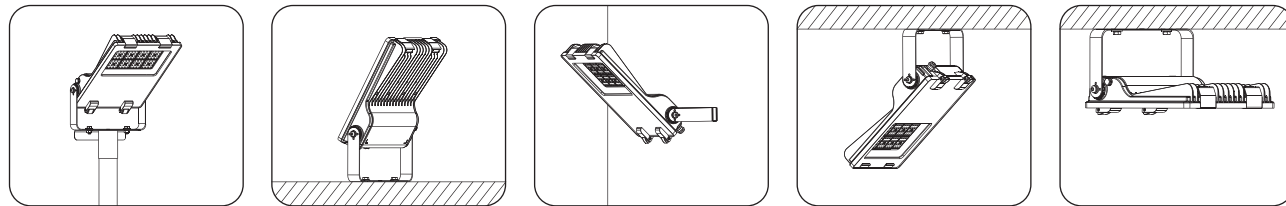

### EN

Professional flood lighting with outdoor sport.

#### General Data

**Voltage:** 100-240 /277V 50 /60Hz

**LED:** PHILIPS LUMILEDS

**Driver:** INVENTRONICS /SOSEN

**Body:** High pressure die-cast aluminum

**Colour:** Gray

**Cover:** Toughened glass and Polycarbonate

**Mounting:** Bracket

**Working Environment:** -40°C ~ +50°C; 10%~90%RH

**Protection Class:** Class I (Default)/Class II (30W-240W)

**Optics:** 25°, 60°, 90°, 120° or Asymmetrical

**Lifetime (L70):** 100,000 h

**Available on request:** Photocell, Motion sensor, NTC, OLC, DALI Dimming

### ES

Iluminación de reflector profesional con deportes al aire libre.

#### Información General

**Voltaje:** 100-240 /277V 50 /60Hz

**LED:** PHILIPS LUMILEDS

**Conductor:** INVENTRONICS /SOSEN

**Cuerpo:** Aluminio fundido a alta presión

**Color:** gris

**Cubierta:** vidrio templado y policarbonato

**Montaje:** Montaje de soporte

**Ambiente de trabajo:** -40°C ~ + 50°C; 10% ~ 90% RH

**Clase de protección:** Clase I (predeterminado) /Clase II (30W-240W)

**Óptica:** 25°, 60°, 90°, 120° o asimétrica

**Vida útil (L70):** 100,000 h

**Disponible:** fotocélula, sensor de movimiento, NTC, OLC, atenuación DALI

### FR

Éclairage professionnel pour les sports de plein air.

#### Données Générales

**Tension:** 100-240 /277V 50 /60Hz

**LED:** PHILIPS LUMILEDS

**Alimentation:** INVENTRONICS /SOSEN

**Corps:** Aluminium moulé sous pression

**Couleur:** Gris

**Couverture:** Verre trempé et Polycarbonate

**Montage:** Divers supports

**Environnement de Travail:** -40°C ~ + 50°C; 10% à 90% RH

**Classe de Protection:** Classe I (Par défaut), Classe II (30W-240W)

**Optique:** 25°, 60°, 90°, 120° ou Asymétrique

**Durée de vie (L70):** 100,000 h

**Disponible sur demande:** Photocellule, Capteur de mouvement, NTC, OLC, DALI Dimming

CE  
RoHS

CB  
ENEC

LM-79  
LM-80

IP66  
IK10

TM-21

# LED FLOOD LIGHT



## Regular Version | Versión regular | Version Régulière

Model	Power (W)	Beam Angle (°)	Height (m)	Luminous Flux (lm)	Beam Diameter (m)	COSφ	Dimensions (mm)	Weight (kg)
ZGSM-FL07-30M	30	4200	140	3000 /4000 /5000 /5700	>70	>0.95	350*295*145	2.9
ZGSM-FL07-30M+	30	4650	155	3000 /4000 /5000 /5700	>70	>0.95	350*295*145	2.9
ZGSM-FL07-40M	40	6000	150	3000 /4000 /5000 /5700	>70	>0.95	350*295*145	2.9
ZGSM-FL07-50M	50	7000	140	3000 /4000 /5000 /5700	>70	>0.95	350*295*145	2.9
ZGSM-FL07-60M	60	9000	150	3000 /4000 /5000 /5700	>70	>0.95	425*385*140	4.9
ZGSM-FL07-60M+	60	9900	165	3000 /4000 /5000 /5700	>70	>0.95	425*385*140	4.9
ZGSM-FL07-80M	80	11600	145	3000 /4000 /5000 /5700	>70	>0.95	425*385*140	4.9
ZGSM-FL07-80M+	80	12800	160	3000 /4000 /5000 /5700	>70	>0.95	425*385*140	4.9
ZGSM-FL07-100M	100	14500	145	3000 /4000 /5000 /5700	>70	>0.95	425*385*140	4.9
ZGSM-FL07-120M	120	17400	145	3000 /4000 /5000 /5700	>70	>0.95	425*385*140	4.9
ZGSM-FL07-150L	150	21750	145	3000 /4000 /5000 /5700	>70	>0.95	470*445*145	6.7
ZGSM-FL07-150L+	150	24000	160	3000 /4000 /5000 /5700	>70	>0.95	470*445*145	6.7
ZGSM-FL07-180L	180	27000	150	3000 /4000 /5000 /5700	>70	>0.95	470*445*145	6.7
ZGSM-FL07-180L+	180	27900	155	3000 /4000 /5000 /5700	>70	>0.95	470*445*145	6.7
ZGSM-FL07-200L	200	29000	145	3000 /4000 /5000 /5700	>70	>0.95	470*445*145	6.7
ZGSM-FL07-240L	240	33600	140	3000 /4000 /5000 /5700	>70	>0.95	470*445*145	6.7
ZGSM-FL07-320L	320	49600	155	3000 /4000 /5000 /5700	>70	>0.95	655*570*180	13.5
ZGSM-FL07-320L+	320	51200	160	3000 /4000 /5000 /5700	>70	>0.95	655*570*180	13.5
ZGSM-FL07-400L	400	60000	150	3000 /4000 /5000 /5700	>70	>0.95	655*570*180	13.5

## High Efficiency | Alta eficiencia | Haute Efficacité

Model	Power (W)	Beam Angle (°)	Height (m)	Luminous Flux (lm)	Beam Diameter (m)	COSφ	Dimensions (mm)	Weight (kg)
ZGSM-FL07-60M	60	9600	160	3000 /4000 /5000 /5700	>70	>0.95	425*385*140	4.9
ZGSM-FL07-60M+	60	10200	170	3000 /4000 /5000 /5700	>70	>0.95	425*385*140	4.9
ZGSM-FL07-80M	80	12400	155	3000 /4000 /5000 /5700	>70	>0.95	425*385*140	4.9
ZGSM-FL07-80M+	80	13200	165	3000 /4000 /5000 /5700	>70	>0.95	425*385*140	4.9
ZGSM-FL07-100M	100	15500	155	3000 /4000 /5000 /5700	>70	>0.95	425*385*140	4.9
ZGSM-FL07-120M	120	18600	155	3000 /4000 /5000 /5700	>70	>0.95	425*385*140	4.9
ZGSM-FL07-150L	150	23250	155	3000 /4000 /5000 /5700	>70	>0.95	470*445*145	6.7
ZGSM-FL07-150L+	150	24750	165	3000 /4000 /5000 /5700	>70	>0.95	470*445*145	6.7
ZGSM-FL07-180L	180	28800	160	3000 /4000 /5000 /5700	>70	>0.95	470*445*145	6.7
ZGSM-FL07-180L+	180	29700	165	3000 /4000 /5000 /5700	>70	>0.95	470*445*145	6.7
ZGSM-FL07-200L	200	31000	155	3000 /4000 /5000 /5700	>70	>0.95	470*445*145	6.7
ZGSM-FL07-240L	240	36000	150	3000 /4000 /5000 /5700	>70	>0.95	470*445*145	6.7
ZGSM-FL07-320L	320	52800	165	3000 /4000 /5000 /5700	>70	>0.95	655*570*180	13.5
ZGSM-FL07-320L+	320	54400	170	3000 /4000 /5000 /5700	>70	>0.95	655*570*180	13.5
ZGSM-FL07-400L	400	64000	160	3000 /4000 /5000 /5700	>70	>0.95	655*570*180	13.5

Luminous flux tolerance +/- 5%. | Tolerancia de flujo luminoso +/- 5% | Tolérance du flux lumineux +/- 5%

## Optic | Óptica | Optique

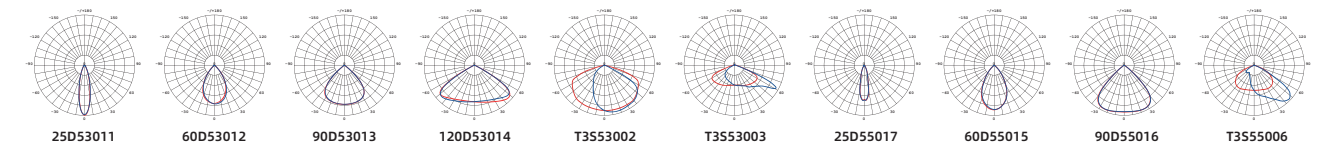

## Accessories | Accesorios | Accessoires



**Primo**



**Installation | Instalación | Installation**

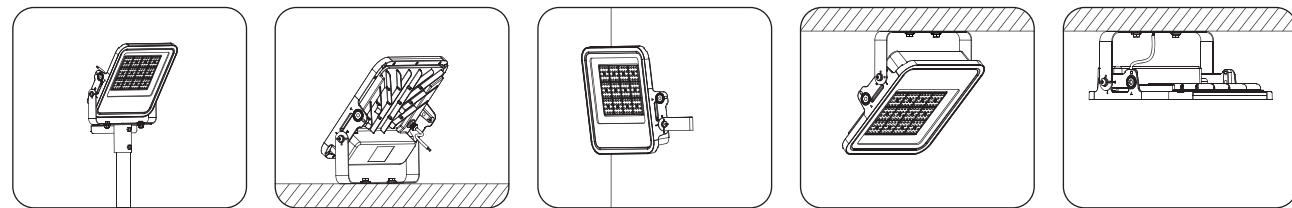

**EN**  
Professional flood lighting with outdoor sport.  
**General Data**  
**Voltage:** 100-240 /277V 50 /60Hz  
**LED:** PHILIPS LUMILEDS  
**Driver:** INVENTRONICS  
**Body:** High pressure die-cast aluminum  
**Colour:** White  
**Cover:** Toughened glass  
**Mounting:** Various brackets  
**Working Environment:** -40°C ~ +50°C; 10% ~ 90%RH  
**Protection Class:** Class I, Class II is optional  
**Optics:** 25°, 60°, 90°, 120° or Asymmetrical  
**Lifetime (L70):** 100,000 h  
**Available on request:** Motion sensor, NTC, OLC, DALI Dimming

**ES**  
Iluminación de reflector profesional con deportes al aire libre.  
**Información General**  
**Voltaje:** 100-240 /277V 50 /60Hz  
**LED:** PHILIPS LUMILEDS  
**Conductor:** INVENTRONICS  
**Cuerpo:** Aluminio fundido a alta presión  
**Color:** Blanco  
**Cubierta:** Vidrio templado  
**Montaje:** varios soportes  
**Ambiente de trabajo:** -40°C ~ + 50°C; 10% ~ 90% RH  
**Clase de protección:** Clase I, Clase II es opcional  
**Óptica:** 25°, 60°, 90°, 120° o Asimétrica  
**Vida útil (L70):** 100,000 h  
**Disponible:** Sensor de movimiento, NTC, OLC, atenuación DALI

**FR**  
Éclairage professionnel pour les sports de plein air.  
**Données Générales**  
**Tension:** 100-240 /277V 50 /60Hz  
**LED:** PHILIPS LUMILEDS  
**Alimentation:** INVENTRONICS  
**Corps:** Aluminium moulé sous pression  
**Couleur:** Blanc  
**Couverture:** Verre Trempé  
**Montage:** Divers supports  
**Environnement de Travail:** -40°C ~ + 50°C; 10% à 90% RH  
**Classe de Protection:** Classe I, Classe II est optionnelle  
**Optique:** 25°, 60°, 90°, 120° ou Asymétrique  
**Durée de vie (L70):** 100,000 h  
**Disponible sur demande:** Capteur de mouvement, NTC, OLC, DALI Dimming

CE / RoHS    CB / TM-21    LM-79 / LM-80    IP66 / IK10    ATEX

**LED FLOOD LIGHT**



**Regular Version | Versión regular | Version Régulière**

ZGSM-GS04-80BF	80	13200	165	3000 /4000 /5000 /5700	>70	>0.95	380*380*150	4.6
ZGSM-GS04-100BF	100	16000	160	3000 /4000 /5000 /5700	>70	>0.95	380*380*150	4.6
ZGSM-GS04-120BF	120	19200	160	3000 /4000 /5000 /5700	>70	>0.95	380*380*150	4.6
ZGSM-GS04-150BF	150	23250	155	3000 /4000 /5000 /5700	>70	>0.95	380*380*150	4.6

**Dimension | Dimensiones | Dimension**

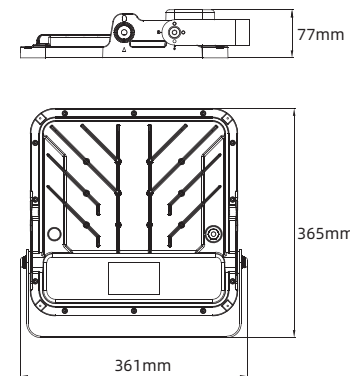

**Optic | Óptica | Optique**

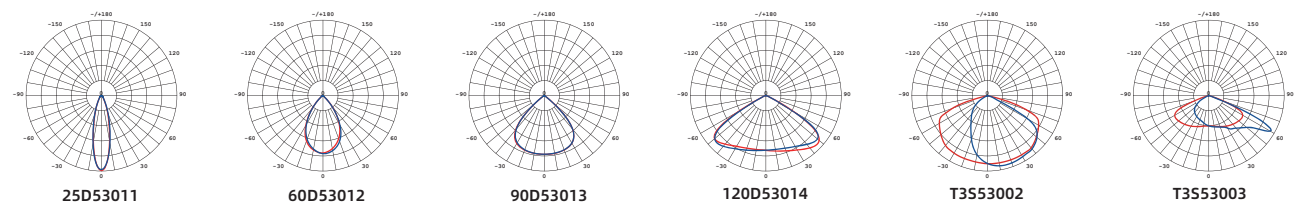

**Accessories | Accesorios | Accessoires**



Primo





## LED CANOPY LIGHT LUMINARIA PARA GASOLINERA LUMINAIRE ENCASTRÉ LED

### EN

ZGSM LED canopy light is mainly designed for gas station and toll station. Power ranging from 40w to 240w can fulfill requirements of most canopy lightings. ATEX certification ensures the safety of lamps used in flammable and explosive places.

### ES

Familia de luminarias LED para gasolinera ZGSM diseñada principalmente para gasolineras y estaciones de peaje. Rango de potencia de 40w a 240w que puede cumplir con los requisitos de la mayoría de la iluminación de toldo, la certificación ATEX garantiza la seguridad de las lámparas utilizadas en lugares inflamables y explosivos.

### FR

La famille des luminaires encastrés LED ZGSM est principalement conçue pour les stations-service et les stations de péage. La plage de puissance de 40w à 240w peut répondre aux exigences de la plupart des plafonniers. La certification ATEX garantit la sécurité des lampes utilisées dans les endroits inflammables et explosifs.



A



CE / RoHS | TM-21 / LM-80 | IP65 / IK10

# LED CANOPY LIGHT



## Regular Version | Versión regular | Version Régulière

Model	Length (mm)	Width (mm)	Height (mm)	Power (W)	Beam Angle (°)	lm	lm/W	CCT (K)	Ra/CRI	COSΦ PF	Weight (kgs)
ZGSM-QD40A4	40	5600	140	3000 / 4000 / 5000 / 5700	>70	>0.95	415*200*195	4.0			
ZGSM-QD50A5	50	6750	135	3000 / 4000 / 5000 / 5700	>70	>0.95	415*200*195	4.0			
ZGSM-QD60A6	60	7800	130	3000 / 4000 / 5000 / 5700	>70	>0.95	415*200*195	4.0			
ZGSM-QD80A4	80	11200	140	3000 / 4000 / 5000 / 5700	>70	>0.95	415*285*195	6.7			
ZGSM-QD100A5	100	13500	135	3000 / 4000 / 5000 / 5700	>70	>0.95	415*285*195	6.7			
ZGSM-QD120A6	120	15600	130	3000 / 4000 / 5000 / 5700	>70	>0.95	415*285*195	6.7			
ZGSM-QD120A4	120	16800	140	3000 / 4000 / 5000 / 5700	>70	>0.95	415*365*195	8.7			
ZGSM-QD150A5	150	20250	135	3000 / 4000 / 5000 / 5700	>70	>0.95	415*365*195	8.7			
ZGSM-QD180A6	180	23400	130	3000 / 4000 / 5000 / 5700	>70	>0.95	415*365*195	8.7			
ZGSM-QD160A4	160	22400	140	3000 / 4000 / 5000 / 5700	>70	>0.95	455*455*195	10.4			
ZGSM-QD200A5	200	27000	135	3000 / 4000 / 5000 / 5700	>70	>0.95	455*455*195	10.4			

Luminous flux tolerance +/- 5% | Tolerancia de flujo luminoso +/- 5% | Tolérance du flux lumineux +/- 5%

## Dimension | Dimensiones | Dimension

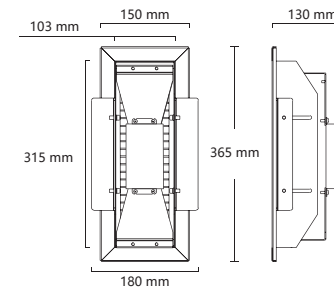

1 Module | 1 Módulo | 1 Module

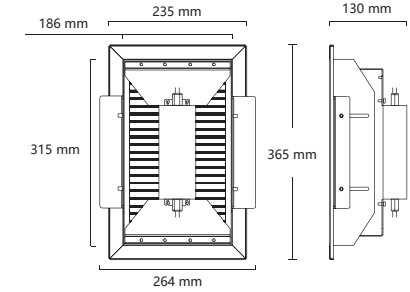

2 Modules | 2 Módulo | 2 Modules

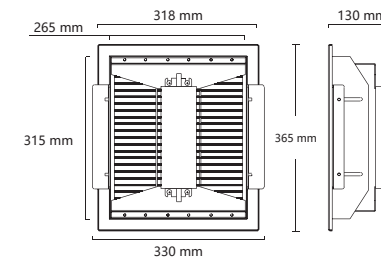

3 Modules | 3 Módulo | 3 Modules

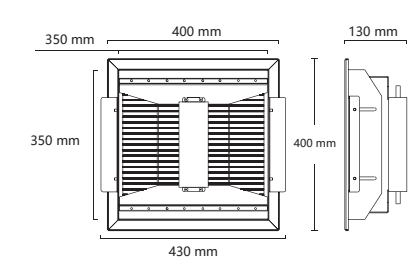

4 Modules | 4 Módulo | 4 Modules

## Installation | Instalación | Installation

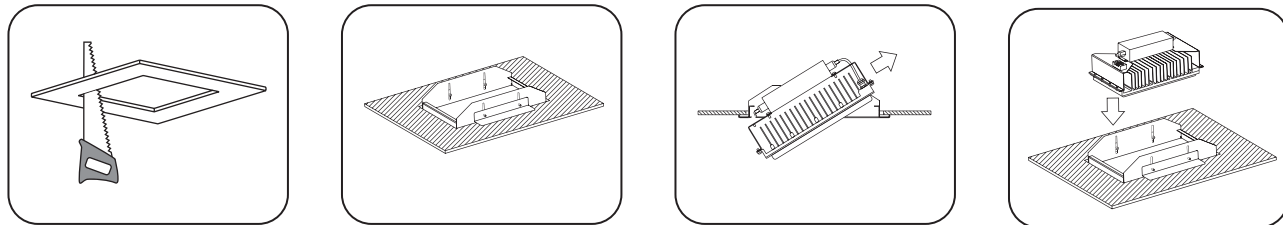

### EN

Safe and reliable LED canopy light for gas station.

#### General Data

**Voltage:** 100-240 / 277V 50 / 60Hz  
**LED:** PHILIPS LUMILEDS  
**Driver:** MEANWELL  
**Body:** Stretched aluminum  
**Colour:** White  
**Cover:** Polycarbonate  
**Mounting:** Recessed  
**Working Environment:** -40°C ~ +50°C; 10% ~ 90%RH  
**Protection Class:** Class I, Class II is optional  
**Optics:** 110 degrees  
**Lifetime (L70):** 100,000h  
**Available on request:** DALI, DIM 1-10V, OLC, TIMER DIM

### ES

Luz de marquesina segura y fiable para la gasificación.

#### Información General

**Voltaje:** 100-240 / 277V 50 / 60Hz  
**LED:** PHILIPS LUMILEDS  
**Conductor:** MEANWELL  
**Cuerpo:** Aluminio estirado  
**Color:** Blanco  
**Cubierta:** Policarbonato  
**Montaje:** Empotrado  
**Ambiente de trabajo:** -40°C ~ +50°C; 10% ~ 90%RH  
**Clase de protección:** Clase I, Clase II es opcional  
**Óptica:** 110 grados  
**Vida útil (L70):** 100,000h  
**Disponible:** DALI, DIM 1-10V, OLC, TIMER DIM

### FR

Luminaire encastré sûr et fiable pour station-service.

#### Données Générales

**Tension:** 100-240 / 277V 50 / 60Hz  
**LED:** PHILIPS LUMILEDS  
**Alimentation:** MEANWELL  
**Corps:** Aluminium Étiré  
**Couleur:** Blanc  
**Couverture:** Polycarbonate  
**Montage:** Encastré  
**Environnement de Travail:** -40°C ~ +50°C; 10% ~ 90%RH  
**Classe de Protection:** Classe I, Classe II est optionnelle  
**Optique:** 110 degrés  
**Durée de Vie (L70):** 100,000h  
**Disponible sur demande:** DALI, DIM 1-10V, OLC, TIMER DIM

## Optic | Óptica | Optique

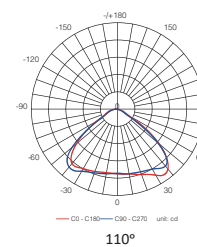

## Accessories | Accesorios | Accessoires

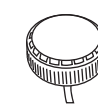

Motion Sensor  
Sensor de movimiento  
Capteur de Mouvement

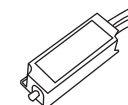

Zigbee Controller  
Controlador Zigbee  
Contrôleur Zigbee

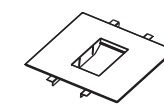

Customized frame  
Marco personalizado  
Cadre personnalisé



H



CE  
RoHS

CB  
SAA

TM-21  
LM-80

IP66  
IK10

ATEX  
LM-79

# LED CANOPY LIGHT



## Regular Version | Versión regular | Version Régulière

Model	W	H	D	Options	W	COSΦ	Size	Weight
ZGSM-QD40H4	40	5600	140	3000 /4000 /5000 /5700	>70	>0.95	285*370*200	3.1
ZGSM-QD50H5	50	6500	130	3000 /4000 /5000 /5700	>70	>0.95	285*370*200	3.1
ZGSM-QD60H6	60	7500	125	3000 /4000 /5000 /5700	>70	>0.95	285*370*200	3.1
ZGSM-QD80H4	80	11200	140	3000 /4000 /5000 /5700	>70	>0.95	355*370*200	4.4
ZGSM-QD100H5	100	13000	130	3000 /4000 /5000 /5700	>70	>0.95	355*370*200	4.4
ZGSM-QD120H6	120	15000	125	3000 /4000 /5000 /5700	>70	>0.95	355*370*200	4.4
ZGSM-QD120H4	120	16800	140	3000 /4000 /5000 /5700	>70	>0.95	430*370*200	5.4
ZGSM-QD150H5	150	19500	130	3000 /4000 /5000 /5700	>70	>0.95	430*370*200	5.4
ZGSM-QD180H6	180	22500	125	3000 /4000 /5000 /5700	>70	>0.95	430*370*200	5.4
ZGSM-QD160H4	160	22400	140	3000 /4000 /5000 /5700	>70	>0.95	505*370*200	6.3
ZGSM-QD200H5	200	26000	130	3000 /4000 /5000 /5700	>70	>0.95	505*370*200	6.3
ZGSM-QD240H6	240	30000	125	3000 /4000 /5000 /5700	>70	>0.95	505*370*200	6.3

## High Efficiency | Alta eficiencia | Haute Efficacité

Model	W	H	D	Options	W	COSΦ	Size	Weight
ZGSM-QD40H4	40	6600	165	3000 /4000 /5000 /5700	>70	>0.95	285*370*200	3.1
ZGSM-QD50H5	50	8000	160	3000 /4000 /5000 /5700	>70	>0.95	285*370*200	3.1
ZGSM-QD60H6	60	9300	155	3000 /4000 /5000 /5700	>70	>0.95	285*370*200	3.1
ZGSM-QD80H4	80	13200	165	3000 /4000 /5000 /5700	>70	>0.95	355*370*200	4.4
ZGSM-QD100H5	100	16000	160	3000 /4000 /5000 /5700	>70	>0.95	355*370*200	4.4
ZGSM-QD120H6	120	18600	155	3000 /4000 /5000 /5700	>70	>0.95	355*370*200	4.4
ZGSM-QD120H4	120	19800	165	3000 /4000 /5000 /5700	>70	>0.95	430*370*200	5.4
ZGSM-QD150H5	150	24000	160	3000 /4000 /5000 /5700	>70	>0.95	430*370*200	5.4
ZGSM-QD180H6	180	27900	155	3000 /4000 /5000 /5700	>70	>0.95	430*370*200	5.4
ZGSM-QD160H4	160	26400	165	3000 /4000 /5000 /5700	>70	>0.95	505*370*200	6.3
ZGSM-QD200H5	200	32000	160	3000 /4000 /5000 /5700	>70	>0.95	505*370*200	6.3
ZGSM-QD240H6	240	37200	155	3000 /4000 /5000 /5700	>70	>0.95	505*370*200	6.3

Luminous flux tolerance +/- 5%. | Tolerancia de flujo luminoso +/- 5% | Tolérance du flux lumineux +/- 5%

## Installation | Instalación | Installation

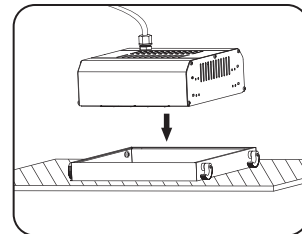
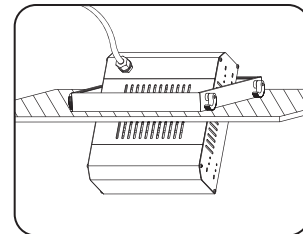
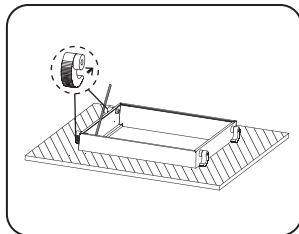
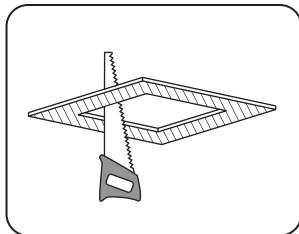

### EN

Safe and reliable LED canopy light for gas station.

#### General Data

**Voltage:** 100-240 /277V 50 /60Hz

**LED:** PHILIPS LUMILEDS

**Driver:** MEANWELL /INVENTRONICS

**Body:** Stretched aluminum

**Colour:** Silver

**Cover:** Polycarbonate

**Mounting:** Recessed

**Working Environment:** -40°C ~ +50°C; 10% ~ 90%RH

**Protection Class:** Class I, Class II is optional

**Optics:** 60, 90 or 110 degrees

**Lifetime (L70):** 100,000h

**Available on request:** DALI, DIM 1-10V, OLC, TIMER DIM

### ES

Luz de techo LED segura y confiable para gasolinera.

#### Información General

**Voltaje:** 100-240 /277V 50 /60Hz

**LED:** PHILIPS LUMILEDS

**Conductor:** MEANWELL /INVENTRONICS

**Cuerpo:** Aluminio estirado

**Color:** Plateado

**Cubierta:** Policarbonato

**Montaje:** Empotrado

**Ambiente de trabajo:** -40°C ~ +50°C; 10% ~ 90%RH

**Clase de protección:** Clase I, Clase II es opcional

**Óptica:** 60, 90 o 110 grados

**Vida útil (L70):** 100,000h

**Disponible:** DALI, DIM 1-10V, OLC, TIMER DIM

### FR

Luminaire encastré sûr et fiable pour station-service.

#### Données Générales

**Tension:** 100-240 /277V 50 /60Hz

**LED:** PHILIPS LUMILEDS

**Alimentation:** MEANWELL /INVENTRONICS

**Corps:** Aluminium Étiré

**Couleur:** Argenté

**Couverture:** Polycarbonate

**Montage:** Encastré

**Environnement de Travail:** -40°C ~ +50°C; 10% ~ 90%RH

**Classe de Protection:** Classe I, Classe II est optionnelle

**Optique:** 60, 90 ou 110 degrés

**Durée de Vie (L70):** 100,000h

**Disponible sur demande:** DALI, DIM 1-10V, OLC, TIMER DIM

## Optic | Óptica | Optique

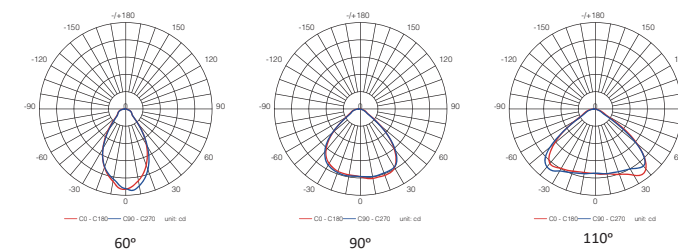

## Accessories | Accesorios | Accessoires

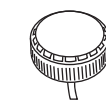

Motion Sensor  
Sensor de movimiento  
Capteur de Mouvement

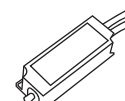

Zigbee Controller  
Controlador Zigbee  
Contrôleur Zigbee

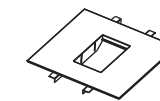

Customized frame  
Marco personalizado  
Cadre personnalisé

Primo



Order Reference  
ZGSM-GS04-80 [5]

- S: Surface Mounting
- R: Recessed Mounting
- B: Bracket Mounting

Surface Mounting  
Montaje superficial  
Montage en Surface

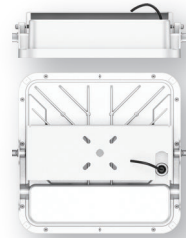

Recessed Mounting  
Montaje empotrado  
Montage Encastré



Bracket Mounting  
Montaje de soporte  
Montage de Support

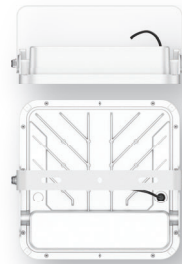

**EN**

Safe and reliable LED canopy light for gas station.

**General Data**

- Voltage:** 100-240 /277V 50 /60Hz
- LED:** PHILIPS LUMILEDS
- Driver:** INVENTRONICS
- Body:** High pressure die-cast aluminum
- Colour:** White
- Cover:** Toughened glass
- Mounting:** Surface /Recessed /Bracket
- Working Environment:** -40°C ~ +50°C; 10% ~90%RH
- Protection Class:** Class I, Class II is optional
- Optics:** 60, 90 or 120 degrees
- Lifetime (L70):** 100, 000h
- Available on request:** Motion sensor, NTC, OLC, DALI Dimming

**ES**

Luz de marquesina segura y fiable para la gasificación.

**Información General**

- Voltaje:** 100-240 /277V 50 /60Hz
- LED:** PHILIPS LUMILEDS
- Conductor:** INVENTRONICS
- Cuerpo:** Aluminio fundido a alta presión
- Color:** Blanco
- Cubierta:** Vidrio templado
- Montaje:** superficial /empotrado /soporte
- Ambiente de trabajo:** -40°C ~ +50°C; 10% ~ 90%RH
- Clase de protección:** Clase I, Clase II es opcional
- Óptica:** 60, 90 o 120 grados
- Vida útil (L70):** 100, 000h
- Disponible:** Sensor de movimiento, NTC, OLC, atenuación DALI

**FR**

Luminaire encastré sûr et fiable pour station-service.

**Données Générales**

- Tension:** 100-240 /277V 50 /60Hz
- LED:** PHILIPS LUMILEDS
- Alimentation:** INVENTRONICS
- Corps:** Aluminium moulé sous pression
- Couleur:** Blanc
- Couverture:** Verre Trempé
- Montage:** Surface /Encastré /Support
- Environnement de Travail:** -40°C ~ +50°C; 10% ~90%RH
- Classe de Protection:** Classe I, Classe II est optionnelle
- Optique:** 60, 90 ou 120 degrés
- Durée de Vie (L70):** 100, 000h
- Disponible sur demande:** Capteur de mouvement, NTC, OLC, DALI Dimming

CE RoHS CB TM-21 LM-79 LM-80 IP66 IK10 ATEX

**LED CANOPY LIGHT**



**Regular Version | Versión regular | Version Régulière**

ZGSM-GS04-80S	80	13200	165	3000 /4000 /5000 /5700	>70	>0.95	380*380*150	4.9
ZGSM-GS04-100S	100	16000	160	3000 /4000 /5000 /5700	>70	>0.95	380*380*150	4.9
ZGSM-GS04-120S	120	19200	160	3000 /4000 /5000 /5700	>70	>0.95	380*380*150	4.9
ZGSM-GS04-150S	150	23250	155	3000 /4000 /5000 /5700	>70	>0.95	380*380*150	4.9
ZGSM-GS04-80R	80	13200	165	3000 /4000 /5000 /5700	>70	>0.95	425*425*145	5.6
ZGSM-GS04-100R	100	16000	160	3000 /4000 /5000 /5700	>70	>0.95	425*425*145	5.6
ZGSM-GS04-120R	120	19200	160	3000 /4000 /5000 /5700	>70	>0.95	425*425*145	5.6
ZGSM-GS04-150R	150	23250	155	3000 /4000 /5000 /5700	>70	>0.95	425*425*145	5.6
ZGSM-GS04-80B	80	13200	165	3000 /4000 /5000 /5700	>70	>0.95	380*380*150	4.6
ZGSM-GS04-100B	100	16000	160	3000 /4000 /5000 /5700	>70	>0.95	380*380*150	4.6
ZGSM-GS04-120B	120	19200	160	3000 /4000 /5000 /5700	>70	>0.95	380*380*150	4.6
ZGSM-GS04-150B	150	23250	155	3000 /4000 /5000 /5700	>70	>0.95	380*380*150	4.6

Luminous flux tolerance +/- 5%. | Tolerancia de flujo luminoso +/- 5% | Tolérance du flux lumineux +/- 5%

**Dimension | Dimensiones | Dimension**

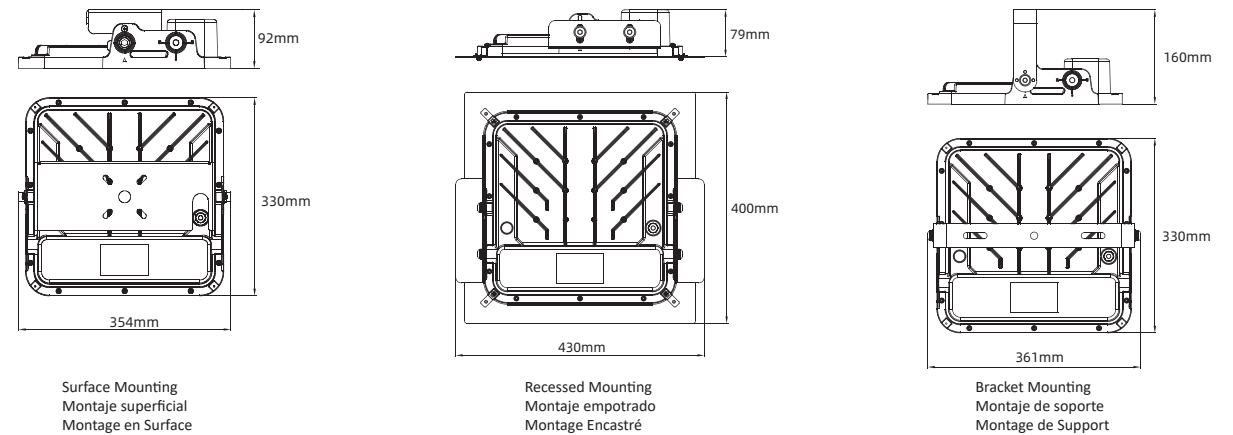

**Optic | Óptica | Optique**

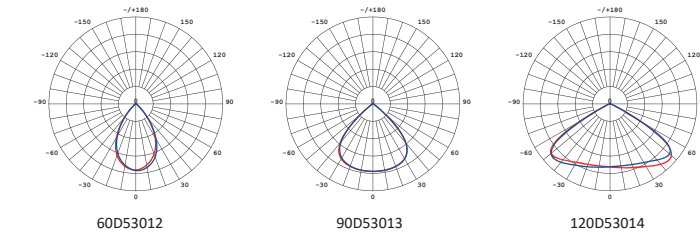

**Accessories | Accesorios | Accessoires**

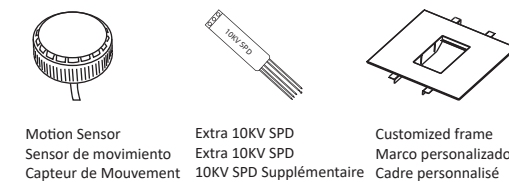





## LED TUNNEL LIGHT LUMINARIA LED PARA TÚNEL LUMINAIRE DE TUNNEL LED

### EN

ZGSM LED tunnel light is suitable for using in all tunnel and underpass areas of roadway and railroad applications. IP66 rating, low copper aluminum housing, surface oxidation treatment process are all designed to meet a longtime salt fog rating. Its universal design can be applied to either wall or ceiling mount tunnel lighting applications with an optional adjustable feature for various tilt angles.

### ES

La luminaria LED para túnel ZGSM es adecuada para su uso en todas las áreas de túneles y pasos subterráneos para aplicaciones en carreteras y ferrocarriles. Diseño con clasificación IP66, carcasa de aluminio con bajo contenido de cobre, proceso de tratamiento de oxidación superficial diseñado para cumplir con una clasificación de niebla salina de larga duración. Su diseño universal se puede aplicar a aplicaciones de iluminación de túneles de montaje en pared o techo con una función ajustable opcional para varios ángulos de inclinación.

### FR

Le luminaire de tunnel LED ZGSM convient à toutes les zones de tunnel et de passage souterrain des applications routières et ferroviaires. La conception d'indice de protection IP66, le boîtier en aluminium à faible teneur en cuivre et le processus de traitement d'oxydation de surface conçu pour atteindre la classe de brouillard salin à long terme. Sa conception universelle peut être appliquée aux applications d'éclairage de tunnel à montage mural ou au plafond, et dispose de fonctions optionnelles et réglables pour différents angles d'inclinaison.





CE CB RoHS SAA TM-21 LM-80 IP66 IK10

# LED TUNNEL LIGHT



## Regular Version | Versión regular | Version Régulière

Model	Length (mm)	Width (mm)	Height (mm)	Power (W)	Beam Spread (°)	Beam Angle (°)	Beam Diameter (mm)	Weight (kgs)
ZGSM-SDD40H4	40	5600	140	3000/4000/5000/5700	>70	>0.95	285*370*200	3.0
ZGSM-SDD50H5	50	6500	130	3000/4000/5000/5700	>70	>0.95	285*370*200	3.0
ZGSM-SDD60H6	60	7500	125	3000/4000/5000/5700	>70	>0.95	285*370*200	3.0
ZGSM-SDD80H4	80	11200	140	3000/4000/5000/5700	>70	>0.95	355*370*200	4.3
ZGSM-SDD100H5	100	13000	130	3000/4000/5000/5700	>70	>0.95	355*370*200	4.3
ZGSM-SDD120H6	120	15000	125	3000/4000/5000/5700	>70	>0.95	355*370*200	4.3
ZGSM-SDD120H4	120	16800	140	3000/4000/5000/5700	>70	>0.95	430*370*200	5.2
ZGSM-SDD150H5	150	19500	130	3000/4000/5000/5700	>70	>0.95	430*370*200	5.2
ZGSM-SDD180H6	180	22500	125	3000/4000/5000/5700	>70	>0.95	430*370*200	5.2
ZGSM-SDD160H4	160	22400	140	3000/4000/5000/5700	>70	>0.95	505*370*200	6.1
ZGSM-SDD200H5	200	26000	130	3000/4000/5000/5700	>70	>0.95	505*370*200	6.1
ZGSM-SDD240H6	240	30000	125	3000/4000/5000/5700	>70	>0.95	505*370*200	6.1

## High Efficiency | Alta eficiencia | Haute Efficacité

Model	Length (mm)	Width (mm)	Height (mm)	Power (W)	Beam Spread (°)	Beam Angle (°)	Beam Diameter (mm)	Weight (kgs)
ZGSM-SDD40H4	40	6600	165	3000/4000/5000/5700	>70	>0.95	285*370*200	3.0
ZGSM-SDD50H5	50	8000	160	3000/4000/5000/5700	>70	>0.95	285*370*200	3.0
ZGSM-SDD60H6	60	9300	155	3000/4000/5000/5700	>70	>0.95	285*370*200	3.0
ZGSM-SDD80H4	80	13200	165	3000/4000/5000/5700	>70	>0.95	355*370*200	4.3
ZGSM-SDD100H5	100	16000	160	3000/4000/5000/5700	>70	>0.95	355*370*200	4.3
ZGSM-SDD120H6	120	18600	155	3000/4000/5000/5700	>70	>0.95	355*370*200	4.3
ZGSM-SDD120H4	120	19800	165	3000/4000/5000/5700	>70	>0.95	430*370*200	5.2
ZGSM-SDD150H5	150	24000	160	3000/4000/5000/5700	>70	>0.95	430*370*200	5.2
ZGSM-SDD180H6	180	27900	155	3000/4000/5000/5700	>70	>0.95	430*370*200	5.2
ZGSM-SDD160H4	160	26400	165	3000/4000/5000/5700	>70	>0.95	505*370*200	6.1
ZGSM-SDD200H5	200	32000	160	3000/4000/5000/5700	>70	>0.95	505*370*200	6.1
ZGSM-SDD240H6	240	37200	155	3000/4000/5000/5700	>70	>0.95	505*370*200	6.1

Luminous flux tolerance +/- 5%. | Tolerancia de flujo luminoso +/- 5% | Tolérance du flux lumineux +/- 5%

## Installation | Instalación | Installation

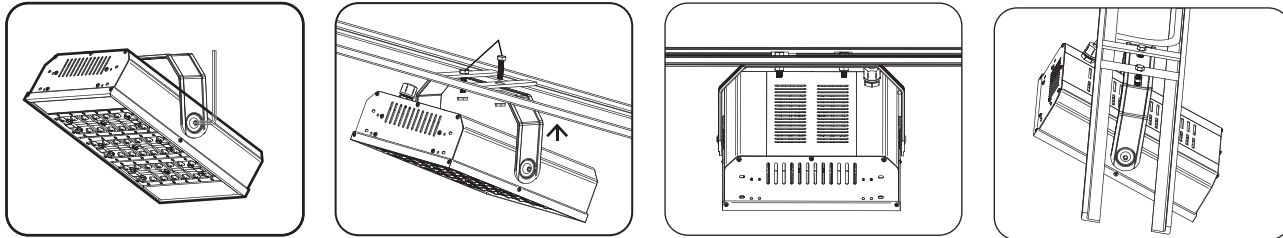

### EN

Excellent tunnel luminaire with LED light sources.

#### General Data

**Voltage:** 100-240 /277V 50 /60Hz

**LED:** PHILIPS LUMILEDS

**Driver:** MEANWELL /INVENTRONICS

**Body:** Stretched aluminum

**Colour:** Silver

**Cover:** Polycarbonate

**Mounting:** Various brackets

**Working Environment:** -40°C ~ +50°C; 10% ~ 90%RH

**Protection Class:** Class I, Class II is optional

**Optics:** Type I, Type II, Type III, Type V

**Lifetime (L70):** 100,000h

**Available on request:** DALI, DIM 1-10V, OLC, TIMER DIM

### ES

Excelente luminaria de túnel con fuentes de luz LED.

#### Información General

**Voltaje:** 100-240 /277V 50 /60Hz

**LED:** PHILIPS LUMILEDS

**Conductor:** MEANWELL /INVENTRONICS

**Cuerpo:** Aluminio estirado

**Color:** Plateado

**Cubierta:** Policarbonato

**Montaje:** Varios soportes

**Ambiente de trabajo:** -40°C ~ +50°C; 10% ~ 90%RH

**Clase de protección:** Clase I, Clase II es opcional

**Óptica:** Tipo I, Tipo II, Tipo III, Tipo V

**Vida útil (L70):** 100,000h

**Disponible:** DALI, DIM 1-10V, OLC, TIMER DIM

### FR

Excellent luminaire de tunnel avec sources lumineuses LED.

#### Données Générales

**Tension:** 100-240 /277V 50 /60Hz

**LED:** PHILIPS LUMILEDS

**Alimentation:** MEANWELL /INVENTRONICS

**Corps:** Aluminium Étiré

**Couleur:** Argenté

**Couverture:** Polycarbonate

**Montage:** Divers supports

**Environnement de Travail:** -40°C ~ +50°C; 10% ~ 90%RH

**Classe de Protection:** Classe I, Classe II est optionnelle

**Optique:** Type I, Type II, Type III, Type V

**Durée de Vie (L70):** 100,000h

**Disponible sur demande:** DALI, DIM 1-10V, OLC, TIMER DIM

## Optic | Óptica | Optique

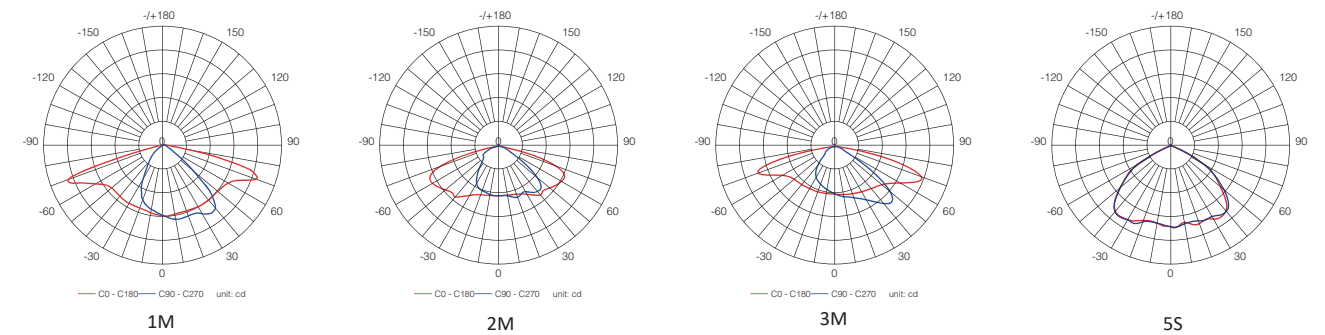

## Accessories | Accesorios | Accessoires

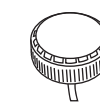

Motion Sensor  
Sensor de movimiento  
Capteur de Mouvement

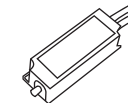

Zigbee Controller  
Controlador Zigbee  
Contrôleur Zigbee





## LED PROJECTOR LIGHT LUMINARIA LED PARA ESTADIO ÉCLAIRAGE DE STADE LED

### EN

ZGSM LED Projector Light is optimized for customers requiring a LED solution for expressway, freeway interchanges, sports fields, airports and other large area applications. The modern design incorporates the big heat sink for heat transfer to prolong LED life. This reliable unit has a 100,000-hour design life, significantly reducing maintenance needs and expense over the life of the fixture. This efficient solution lowers energy consumption compared to traditional HID fixtures for additional operating cost savings.

### ES

El proyector LED ZGSM está optimizado para clientes que requieren una solución LED para autopistas, intercambios de autopistas, campos deportivos, aeropuertos y otras aplicaciones de áreas grandes. El diseño moderno incorpora el gran disipador de calor para la transferencia de calor para prolongar la vida útil del LED. Esta unidad confiable tiene una vida útil de 100,000 horas, lo que reduce significativamente las necesidades de mantenimiento y los gastos durante la vida útil del dispositivo. Esta solución eficiente reduce el consumo de energía en comparación con los dispositivos HID tradicionales para ahorrar costos operativos adicionales.

### FR

L'éclairage de stade LED ZGSM est optimisé pour les clients nécessitant des solutions LED pour les autoroutes, les échangeurs d'autoroutes, les terrains de sport, les aéroports et d'autres applications de grande superficie. La conception moderne intègre de grands dissipateurs de chaleur pour le transfert de chaleur afin de prolonger la durée de vie de LED. Cet appareil fiable a une durée de vie de 100 000 heures, ce qui réduit considérablement les besoins d'entretien et les dépenses tout au long de la vie de l'appareil. Par rapport aux luminaires HID traditionnels, cette solution efficace réduit la consommation d'énergie pour des économies sur les coûts d'exploitation supplémentaires.





RoHS	CE LM-79	TM-21 LM-80	IP66 IK10
------	-------------	----------------	--------------

CODE	W	lm	lm/W	CCT K	Ra/CRI	COSΦ PF	mm	kg
------	---	----	------	----------	--------	------------	----	----

Regular Version | Versión regular | Version Régulière

ZGSM-TGD280M	280	42000	150	3000 /4000 /5000 /5700	75	>0.95	770*385*235	20.0
ZGSM-TGD560M	560	84000	150	3000 /4000 /5000 /5700	75	>0.95	770*640*235	35.5
ZGSM-TGD840M	840	126000	150	3000 /4000 /5000 /5700	75	>0.95	770*900*235	50.0

Luminous flux tolerance +/- 5%. | Tolerancia de flujo luminoso +/- 5% | Tolérance du flux lumineux +/- 5%

Optic | Óptica | Optique

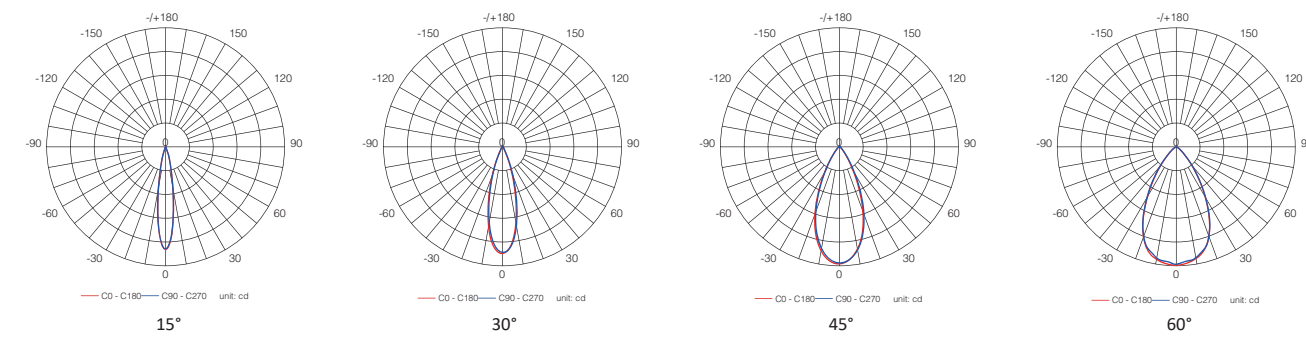

Dimensions | Dimensiones | Dimensions

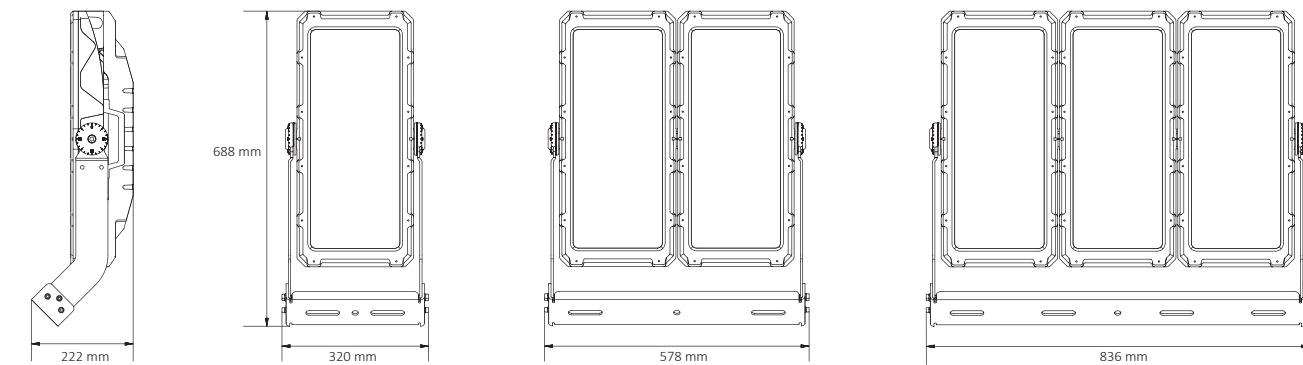

Accessories | Accesorios | Accessoires

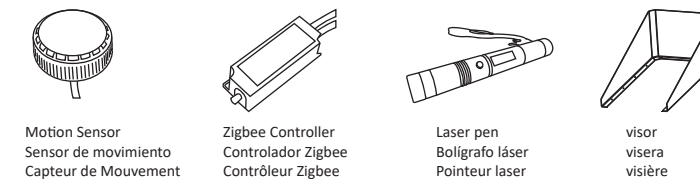

**EN**  
Remarkable modular projector light for sports fields.  
**General Data**  
**Voltage:** 100-240 /277V 50 /60Hz  
**LED:** PHILIPS LUMILEDS  
**Driver:** INVENTRONICS  
**Body:** High pressure die-cast aluminum  
**Colour:** Black  
**Cover:** Toughened glass and Polycarbonate  
**Mounting:** Brackets  
**Working Environment:** -40°C ~ +50°C; 10% ~ 90%RH  
**Protection Class:** Class I, Class II is optional  
**Optics:** 15, 30, 45 or 60 degrees  
**Lifetime (L70):** 100,000 h  
**Available on request:** DALI, DIM 1-10V, OLC, NTC, TIMER DIM

**ES**  
Destacado proyector modular de luz con campos deportivos.  
**Información General**  
**Voltaje:** 100-240 /277V 50 /60Hz  
**LED:** PHILIPS LUMILEDS  
**Conductor:** INVENTRONICS  
**Cuerpo:** Aluminio fundido a alta presión  
**Color:** Negro  
**Cubierta:** Vidrio templado y policarbonato  
**Montaje:** Soportes  
**Ambiente de trabajo:** -40°C ~ +50°C; 10% ~ 90%RH  
**Clase de protección:** Clase I, Clase II es opcional  
**Óptica:** 15, 30, 45 o 60 grados  
**Vida útil (L70):** 100,000 h  
**Disponible:** DALI, DIM 1-10V, OLC, NTC, TIMER DIM

**FR**  
Éclairage de stade modulaire remarquable pour les terrains de sport.  
**Données Générales**  
**Tension:** 100-240 /277V 50 /60Hz  
**LED:** PHILIPS LUMILEDS  
**Alimentation:** INVENTRONICS  
**Corps:** Aluminium moulé sous pression  
**Couleur:** Noir  
**Couverture:** Verre Trempé et Polycarbonate  
**Montage:** Supports  
**Environnement de Travail:** -40°C ~ +50 °C; 10% ~ 90%RH  
**Classe de Protection:** Classe I, Classe II est optionnelle  
**Optique:** 15, 30, 45 ou 60 degrés  
**Durée de Vie (L70):** 100,000 h  
**Disponible sur demande:** DALI, DIM 1-10V, OLC, NTC, TIMER DIM





## SOLAR STREET LIGHT LUMINARIA SOLAR PARA CALLE LAMPADAIRE SOLAIRE

### EN

ZGSM outdoor solar LED street lights provide high intensity lighting at night while consuming no electricity. These fantastic lights are extremely cost-effective, best for enhancing safety, easy to install, and require no monthly fees for electricity usage. In addition, they use top-quality components that last several years so your investment will keep shining continuously, every night for a long time.

### ES

Las luminarias LED solares para exteriores ZGSM proporcionan iluminación de alta intensidad por la noche sin consumir electricidad. Estas fantásticas luces son extremadamente rentables, las mejores para mejorar la seguridad, fáciles de instalar y no requieren tarifas mensuales por el uso de electricidad. Además, utilizan componentes de primera calidad que duran varios años por lo que tu inversión seguirá brillando continuamente, todas las noches, durante mucho tiempo.

### FR

Les lampadaires solaires extérieurs LED ZGSM fournissent un éclairage à haute intensité la nuit sans consommation d'électricité. Ces merveilleuses lumières sont extrêmement rentables, idéales pour améliorer la sécurité, faciles à installer et ne nécessitent aucuns frais d'électricité mensuels. De plus, ils utilisent des composants de premier ordre qui durent plusieurs années, de sorte que votre investissement continue à briller en permanence, chaque nuit, pendant longtemps.

PV3



Installation | Instalación | Installation

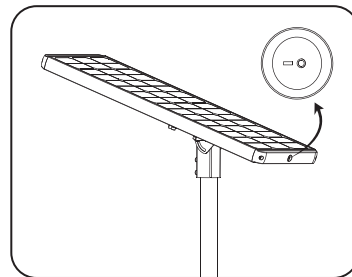
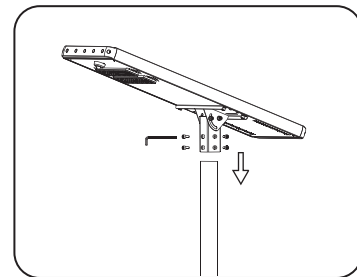
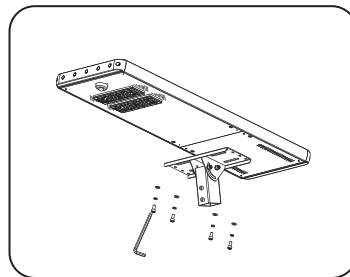

EN

Most environmentally friendly and energy-saving LED lamps.

- General Data**
- Voltage:** DC12V
- LED:** PHILIPS LUMILEDS
- Controller:** Depower
- Solar Panel:** Monocrystalline silicon
- Battery:** Lithium
- Body:** High pressure die-cast aluminum
- Colour:** Silver
- Pole Diameter:** 60 ~ 85mm
- Working Environment:** -20°C ~ +60°C, 10% ~ 90%RH
- Optics:** Type II, Type III, Type V
- Lifetime (L70):** 100,000h
- Available on request:** TIMER DIM, MOTION SENSOR, PIR SENSOR

ES

La mayoría de las lámparas LED de bajo consumo y ecológicas.

- Información General**
- Voltaje:** DC12V
- LED:** PHILIPS LUMILEDS
- Controlador:** Depower
- Panel solar:** Silicio monocristalino
- Batería:** Litio
- Cuerpo:** Aluminio fundido a alta presión
- Color:** Plata
- Diámetro del poste:** 60 ~ 85 mm
- Ambiente de trabajo:** -20°C ~ +60°C, 10% ~ 90%RH
- Óptica:** Tipo II, Tipo III, Tipo V
- Vida útil (L70):** 100,000h
- Disponible:** TIMER DIM, SENSOR DE MOVIMIENTO, SENSOR PIR

FR

Lampes LED les plus écologiques et les plus économes en énergie.

- Données Générales**
- Tension:** DC12V
- LED:** PHILIPS LUMILEDS
- Contrôleur:** Depower
- Panneau solaire:** Silicium monocristallin
- Batterie:** Lithium
- Corps:** Aluminium moulé sous pression
- Couleur:** Argenté
- Diamètre du Mât:** 60 ~ 85mm
- Environnement de Travail:** -40°C ~ +50°C, 10% ~ 90%RH
- Optique:** Type II, Type III, Type V
- Durée de Vie (L70):** 100,000h
- Disponible sur demande:** TIMER DIM, Capteur de Mouvement, Capteur PIR

CE  
RoHS

TM-21  
LM-80

IP65  
IK10

SOLAR STREET LIGHT



50W Monocrystal | 50W Monocrystal | 50W Monocrystal

ZGSM-PV501010	10	2100	210	3000 /4000 /5000 /5700	>70	111	>29.0	2.5	3~4m
ZGSM-PV501510	15	3120	208	3000 /4000 /5000 /5700	>70	111	>19.5	2.5	3~5m
ZGSM-PV502010	20	4100	205	3000 /4000 /5000 /5700	>70	111	>14.5	2.5	4~5m
ZGSM-PV502020	20	4100	205	3000 /4000 /5000 /5700	>70	222	>29.0	4.5	4~5m
ZGSM-PV503020	30	6240	208	3000 /4000 /5000 /5700	>70	222	>19.5	4.5	4~6m
ZGSM-PV504020	40	8200	205	3000 /4000 /5000 /5700	>70	222	>14.5	4.5	5~6m
ZGSM-PV504027	40	8200	205	3000 /4000 /5000 /5700	>70	300	>20.0	6.0	5~6m
ZGSM-PV505027	50	10000	200	3000 /4000 /5000 /5700	>70	300	>16.0	6.0	5~7m

70W Monocrystal | 70W Monocrystal | 70W Monocrystal

ZGSM-PV702020	20	4200	210	3000 /4000 /5000 /5700	>70	222	>29.0	3.5	4~5m
ZGSM-PV703020	30	6240	208	3000 /4000 /5000 /5700	>70	222	>19.5	3.5	4~6m
ZGSM-PV703027	30	6240	208	3000 /4000 /5000 /5700	>70	300	>26.0	4.5	4~6m
ZGSM-PV704020	40	8200	205	3000 /4000 /5000 /5700	>70	222	>14.5	3.5	5~6m
ZGSM-PV704027	40	8200	205	3000 /4000 /5000 /5700	>70	300	>20.0	4.5	5~6m
ZGSM-PV704040	40	8200	205	3000 /4000 /5000 /5700	>70	444	>29.5	6.5	5~6m
ZGSM-PV705027	50	10300	206	3000 /4000 /5000 /5700	>70	300	>16.0	4.5	5~7m
ZGSM-PV705040	50	10300	206	3000 /4000 /5000 /5700	>70	444	>23.5	6.5	5~7m
ZGSM-PV706027	60	12300	205	3000 /4000 /5000 /5700	>70	300	>13.0	4.5	6~8m
ZGSM-PV706040	60	12300	205	3000 /4000 /5000 /5700	>70	444	>19.5	6.5	6~8m

100W Monocrystal | 100W Monocrystal | 100W Monocrystal

ZGSM-PV1003020	30	6300	210	3000 /4000 /5000 /5700	>70	222	>19.5	2.5	4~6m
ZGSM-PV1003027	30	6300	210	3000 /4000 /5000 /5700	>70	300	>26.5	3.0	4~6m
ZGSM-PV1004020	40	8360	209	3000 /4000 /5000 /5700	>70	222	>14.5	2.5	5~6m
ZGSM-PV1004027	40	8360	209	3000 /4000 /5000 /5700	>70	300	>20.0	3.0	5~6m
ZGSM-PV1004040	40	8360	209	3000 /4000 /5000 /5700	>70	444	>29.5	4.5	5~6m
ZGSM-PV1005027	50	10300	206	3000 /4000 /5000 /5700	>70	300	>16.0	3.0	5~7m
ZGSM-PV1005040	50	10300	206	3000 /4000 /5000 /5700	>70	444	>23.5	4.5	5~7m
ZGSM-PV1005045	50	10300	206	3000 /4000 /5000 /5700	>70	500	>26.5	5.0	5~7m
ZGSM-PV1006027	60	12300	205	3000 /4000 /5000 /5700	>70	300	>13.0	3.0	6~8m
ZGSM-PV1006040	60	12300	205	3000 /4000 /5000 /5700	>70	444	>19.5	4.5	6~8m
ZGSM-PV1006045	60	12300	205	3000 /4000 /5000 /5700	>70	500	>22.0	5.0	6~8m

Luminous flux tolerance +/- 5%. | Tolerancia de flujo luminoso +/- 5% | Tolérance du flux lumineux +/- 5%

Optic | Óptica | Optique

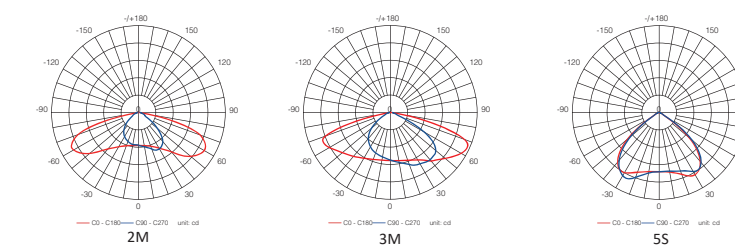

Accessories | Accesorios | Accessoires



Motion/PIR Sensor  
Sensor de movimiento / PIR  
Capteur de Mouvement / PIR



Camera  
Cámara  
Caméra





## LED GROW LIGHT LED LUZ DE CULTIVO LUMINAIRE HORTICOLE LED

### EN

ZGSM LED plant growth lights are suitable for artificial light plant seedlings, leafy vegetable production, greenhouses, and other facilities for agricultural cultivation to supplement light, adjust flowering period, color flowers and fruits, improve taste and quality, promote plant growth, and shorten plant growth cycles. They improve the quality and efficiency of plant output.

### ES

Las luces LED de cultivo para plantas de ZGSM son adecuadas para plántulas de plantas ligeras artificiales, producción de vegetales de hojas, invernaderos y otras instalaciones para el cultivo agrícola para complementar la luz, ajustar el período de floración, colorear flores y frutas, mejorar el sabor y la calidad, promover el crecimiento de las plantas y acortar las plantas. ciclos de crecimiento. Mejorar la calidad y la eficiencia de la producción de la planta.

### FR

Le luminaire horticole LED de ZGSM convient à la culture de jeunes plantes et la production de légumes à feuilles à lumière artificielle, à l'éclairage d'appoint pour la culture agricole dans les serres et autres installations. Il sert à ajuster la période de floraison, colorer les fleurs et les fruits, améliorer le goût et la qualité, favoriser la croissance des plantes et raccourcir cycles de croissance. Il améliore la qualité et l'efficacité de la production végétale.



# Croplustre



**NEW**

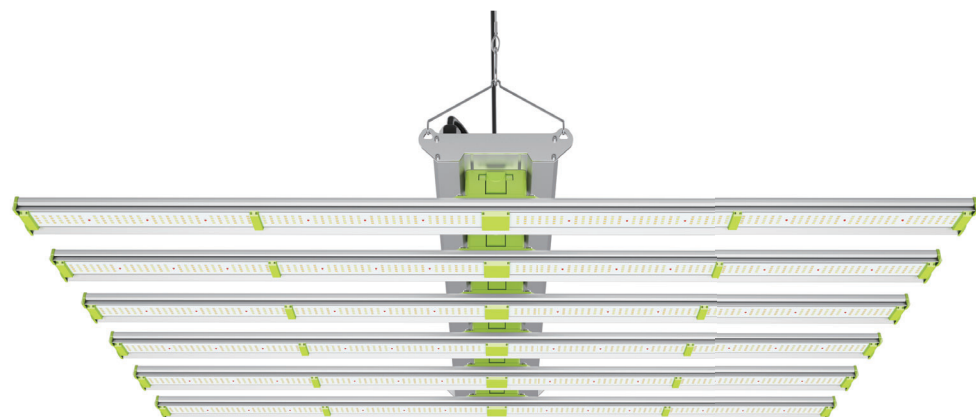

## EN

Full spectrum LED grow light for plants.

### General Data

**Voltage:** 100-240 /277V 50 /60Hz  
**LED:** SAMSUNG LM301B + OSRAM 660 nm  
**Driver:** Sosen  
**Body:** Aluminum with oxide treatment, PC  
**Colour:** Light Silver + Lime Green  
**Mounting:** Hanging  
**Working Environment:** < 40°C, 10% ~ 90%RH  
**Protection Class:** Class I  
**Optics:** 120 deg  
**Lifetime (L70):** > 50,000 hours (11.4 years @ 12 hours/day)  
**Available on request:** DIM 1-10V

## ES

Luz de cultivo LED de espectro completo con plantas

### Información General

**Voltaje:** 100-240 /277V 50 /60Hz  
**LED:** SAMSUNG LM301B + OSRAM 660 nm  
**Conductor:** Sosen  
**Cuerpo:** Aluminio con tratamiento de óxido, PC  
**Color:** Plata claro + verde lima  
**Montaje:** Colgando  
**Ambiente de trabajo:** < 40°C, 10% ~ 90%RH  
**Clase de protección:** Clase I  
**Óptica:** 120 deg  
**Vida útil (L70):** > 50,000 hours horas (11,4 años a 12 horas / día)  
**Disponible:** DIM 1-10V

## FR

Luminaire horticole LED à spectre complet pour les plantes.

### Données Générales

**Tension:** 100-240 /277V 50 /60Hz  
**LED:** SAMSUNG LM301B + OSRAM 660 nm  
**Alimentation:** Sosen  
**Corps:** Aluminium avec traitement d'oxyde, PC  
**Couleur:** Argent Clair + Vert Citron  
**Montage:** Suspendu  
**Environnement de Travail:** < 40°C, 10% ~ 90%RH  
**Classe de Protection:** Classe I  
**Optique:** 120 degrés  
**Durée de Vie (L70):** > 50,000 heures (11.4 ans à 12 heures/jour)  
**Disponible sur demande:** DIM 1-10V

CE  
RoHS

IP20

# LED GROW LIGHT



## Regular Version | Versión regular | Version Régulière

ZGSM-CL420-4	420	2.8	1176	4	2088	3000 /5000	>80	1155*265*175	8.5
ZGSM-CL650-6	650	2.8	1820	6	3132	3000 /5000	>80	1175*400*200	12.5
ZGSM-CL750-7	750	2.8	2100	7	3654	3000 /5000	>80	1175*400*200	13.5

## Spectra | Espectro | Spectre

High Efficiency (All Grow Stages) - Spectrum Code: S001STD  
 Alta eficiencia (todas las etapas de cultivo) - Código de espectro: S001STD  
 Haute efficacité (Toutes les étapes de croissance) - Code de spectre : S001STD

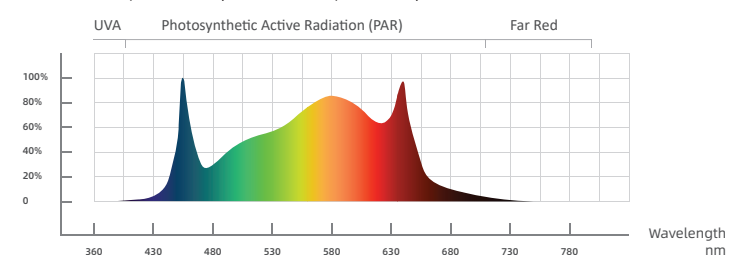

Flowering and Fruiting - Spectrum Code: S002STD  
 Floración y fructificación - Código de espectro: S002STD  
 Floraison et fructification - Code de spectre : S002STD

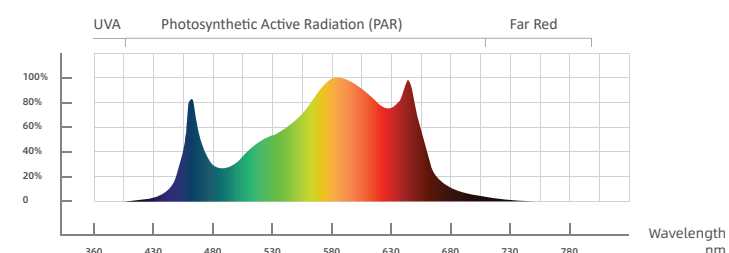

Full Spectrum + UV & IR - Spectrum Code: S003STD  
 Espectro completo + UV e IR - Código de espectro: S003STD  
 Spectre complet + UV et IR - Code de spectre : S003STD

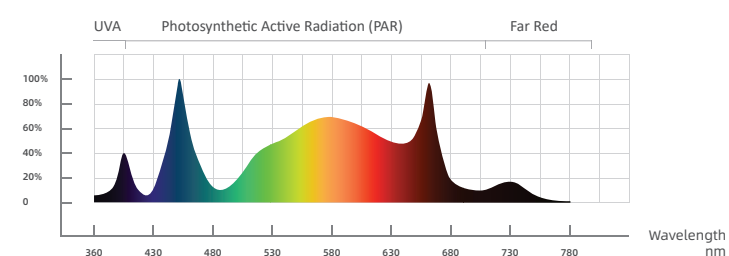

## Optic | Óptica | Optique

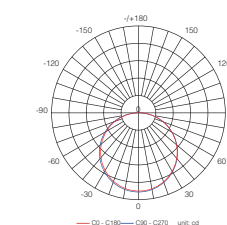



Save todays energy  
for **tomorrow!**

---

---

---

---

---

---

---

---

---

---

---

---

---

---

---

---

---

---

---

---

---

---

---

---

---

---

---

---

---

Quality  
you can trust.

---

---

---

---

---

---

---

---

---

---

---

---

---

---

---

---

---

---

---

---

---

---

---

---

---

---

---

---